

# Magnetic separators

for powders, liquids and bulk materials



# magnetic separators

Applications are found in many different industries. Magnetic separators provide a ferrous-free, high-quality finished product in the food industry as well as in the chemical, pharmaceutical, plastic, ceramic, feed and bulk industries. They also prevent production downtime, product recalls and dust explosions. magnetic separators are designed and manufactured in-house and used for prevention of metal contamination worldwide. This brochure provides you with insight into the possibilities.



## How do you choose the right magnet for your product?

The table below shows some examples of products and the appropriate type of magnet for each. You can always call or e-mail us if you have questions or need advice.

Product particle size	Product characteristics	Product example Note: max. Fe particle size = same as product	Grid	Static Cleanflow – max. capacity 45 m <sup>3</sup> /h	Rotating Cleanflow – max. capacity 45 m <sup>3</sup> /h	Easy Cleanflow – max. capacity 120 m <sup>3</sup> /h	Filter	Bullet magnet – max. capacity 550 m <sup>3</sup> /h	Plate magnet	Chute	External pole 360 m <sup>3</sup> /h	Cascade 300 m <sup>3</sup> /h	Drum 300 m <sup>3</sup> /h	High Gradient	Overbelt
0 - 100 µm	poorly flowing, bridging, sticky	carbon black powder, alu oxide, ceramic powder, pharma powder	•		•	•							•		
100 - 500 µm	poorly flowing, bridging, sticky	icing sugar, milk powder, cocoa powder	•		•	•							•	•	
0.5 - 3.0 mm	free-flowing (granulate)	coarse or fine salt, granulated sugar, sugar, candy sugar, candy, plastic granulate, beaded carbon black	•	•		•			•	•	•		•	•	
0.5 - 3.0 mm	poorly flowing (flakes)	breakfast cereals, fabrics	•		•	•									
3.0 - 6.0 mm	goedstromend	mill material, fabrics	•	•		•		•	•	•	•	•	•	•	
> 6.0 mm	free-flowing (pellets)	oatmeal, breadcrumbs, semolina, rice, maize, wheat, peppercorns, coffee beans, soya, animal feeds				•		•	•	•	•	•	•	•	•
> 6.0 mm	poorly flowing (irregular shapes)	saffron, bay leaf, dried fruit, tea leaves, cornflakes, dried peppers, mushrooms				•		•	•	•	•	•	•	•	•
	liquids	oil, dairy, chocolate, paper pulp, meat pulp, tomato paste					•								
	liquids with coarse particles	sandwich spread, dairy with fruit, soup					•								

# Contents

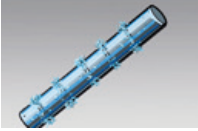
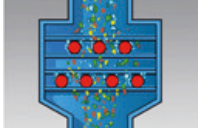
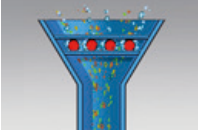
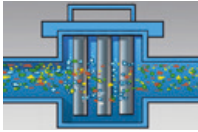
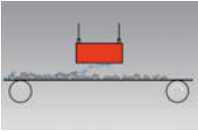
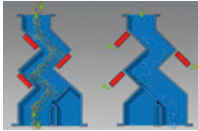
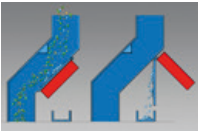
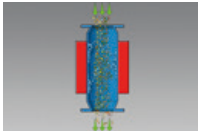
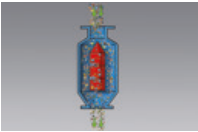
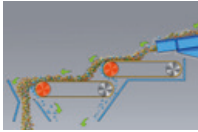
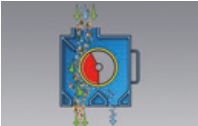
<b>magnetic separators</b>	<b>2</b>		
<b>Design, calculation, production</b>	<b>4</b>		
<b>Magnetic bar systems</b>	<b>6</b>		
 Magnetic bar	6	 Cleanflow magnets	8
 Magnetic grids	7	 Magnetic filters for liquids and powders under pressure	10
<b>Magnetic plate systems</b>	<b>12</b>		
 Plate magnets	13	 Cascade magnets	15
 Chute magnets	14	 External pole magnets	16
<b>Magnetic cylinder systems</b>	<b>17</b>		
 Bullet magnets	17	 High-gradient separators	19
 Magnetic drum separators	18		



# Design, calculation, production

Because we have our own design, production and assembly facilities, you can rest assured that our magnetic systems will meet your requirements and be accompanied by all the necessary quality certificates.

## Magnetic calculations

In order to be able to develop the right magnet system for you faster and better, we perform 3D magnet calculations. This allows us to efficiently optimize magnetic performance and accurately predict how the magnet will behave in terms of:

- depth of the magnetic field
- peaks and troughs in the magnetic field across a surface
- maximum force of the magnet on another ferromagnetic object
- 'residual magnetism' present when in and out position (for switchable magnets)
- separation of particles from a product flow, such as powder or liquid chocolate.

Thanks to our many years of experience, we are able to quantify more and more factors that were previously uncertainties.

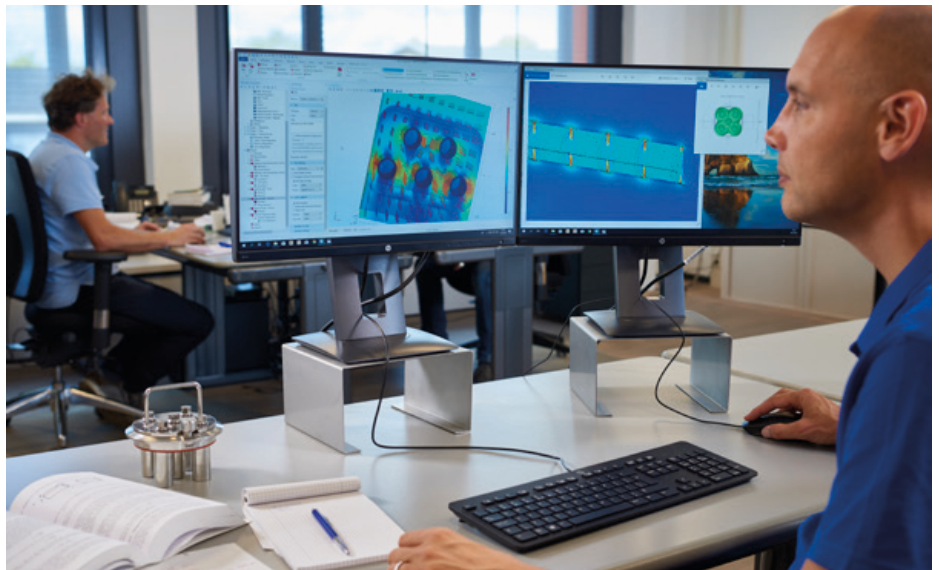

**Magnetic separation efficiency**  
for metal particles  $\varnothing 0.8 \times 2$  mm

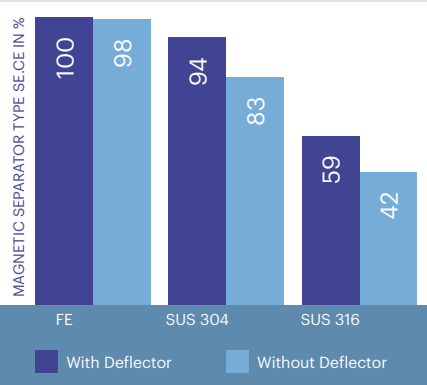

The **effectiveness graph** shows what you can expect from an Easy Cleanflow magnet. The idea is to allow you to enter product parameters so you can know for certain which particles will be captured. We utilize a computer simulation process in which we can change the parameters to match various products. These could be anything from milk powder to cocoa powder or even quartz sand. This enables us to make a prior assessment of the expected effectiveness of our magnetic separators.



Easy Cleanflow magnet

We take this into account in the simulations and therefore also use it to optimize the magnet systems you use.

### What does the gauss value of a magnetic rod tell us, exactly?

The assessment of whether a magnet is strong or not is often based on the gauss value measured at the bar. This gives an indication, but if the magnetic field 2 mm from the measuring point has lost half its value, the effect is gone. Therefore it is more important to know the gauss value in the middle, between two bars. This is the weakest point, and that is what determines the effectiveness. states that all magnetic systems we design must meet a

minimum value of 300 gauss throughout the system.

### Why at least 300 gauss?

After extensive testing, we can prove that  $\varnothing 0.8 \times 2$  mm (C9D 1.0304) Fe particles without product effect are attracted at a drop speed of 0.4 metres per second at a value of 155 gauss. For  $\varnothing 0.8 \times 2$  mm (AISI304 1.4301) stainless steel 304 particles the value is 1,100 gauss, and for  $\varnothing 0.8 \times 2$  mm (AISI316 1.4401) 316 stainless steel particles the value is 10,000 gauss. By using a minimum value of 300 gauss, we are certain that the magnet can capture Fe particles.

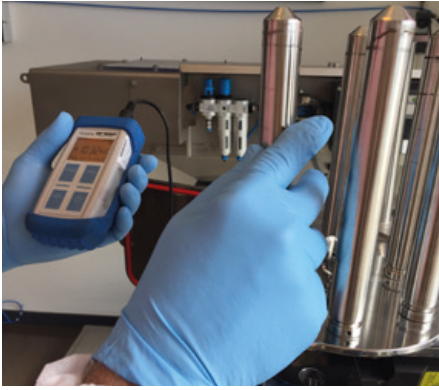

## Verification – measuring equipment – inspections

We can also help you with the inspection of magnets.

Particularly in the food industry, magnetic measurements are a requirement:

- they guarantee the quality of the finished product
- compliance with the HACCP international food safety standard.

Our technicians know exactly how and where to measure and conduct the measurements on-site with a calibrated gaussmeter.

They take care to interrupt your processes as little as possible and carefully analyse all the installed magnet systems. Afterwards, you receive an inspection certificate with any recommendations for process optimization. An overview of the specifications on the inspection certificate can be found on our website. We also supply gaussmeters for your own use.

## Hygienic welding

HDN stands for 'Hygienic Design Network' and is a collaboration of companies in the food industry, ranging from component suppliers and system integrators to food producers. We are a member of the HDN, as are some of our suppliers and large customers in the food industry.

Both welders and welding robot are hygienic HDN/PED certified. This means that all welds have passed the X-ray tests for the European Pressure Equipment Directive (PED). With their HDN certification, they are allowed to weld hygienic and pressure systems.



## EHEDG-certified magnets

The European Hygienic Engineering & Design Group (EHEDG), founded in 1989, is a consortium of manufacturers and suppliers of equipment for the food industry.

They set a standard for the safe, high-quality production of food. is a member of EHEDG, as reducing foreign bodies is very important.

## ATEX directive

We make magnets for use in dust and gas explosion-hazardous environments. Magnets are used to prevent mechanical sparks and thus dust explosions. The ATEX directive (ATEX: ATmosphères EXplosibles) is a European standard intended to prevent gas and dust explosions.



# Magnetic bar systems

Bar systems filter small amounts of very fine iron and weakly magnetic particles – such as processed stainless steel – from 30 µm up to approx. 2 mm out of fine powders, liquids and viscous products present in bulk flows and pipeline transport in various industries.

## Magnetic bars

Magnetic bars form the powerful basis for magnetic filters, grate and Cleanflow magnets. They are available in various sizes with super-strong neodymium (Nd-Fe-B) magnets and filter metal particles as small as 30 µm from powders and granulates.

## Magnetic inspection rods

Magnetic inspection rods enable you to quickly and reliably determine whether your product is contaminated with ferromagnetic (Fe) particles. The inspection rod attracts Fe particles as small as 30 microns. A metal detector does not recognize these very fine Fe particles.

inspection rods are strong neodymium (Neoflux®) magnetic rods enclosed in a stainless steel extractor tube with a handle. Attached Fe particles can be removed easily by sliding the magnetic bar out of the tube, which causes the Fe particles to fall off.

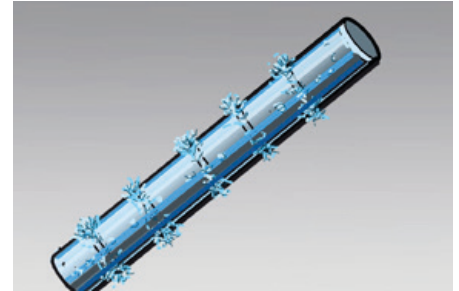

- For free-flowing granulates and powders.
- For free-fall transport.
- Stainless steel separation possible.
- L = 100 – 600 mm.
- Cleaning: manual.



## Magnetic bars

Type number	Max. temp.	Br of magnet material (kg)	Max. flux density at bar	Max. flux density at extractor (aut. system)
GSN 42	70	13,400 - 13,700	10,700 - 11,000	7,800 - (10,000)
GSN 42 SH	140	13,400 - 13,700	10,700 - 11,000	7,800 - (10,000)
GSN 52	60	13,800 - 14,100	11,400 - 12,000	8,400 - (11,000)



## Magnetic grids

Grid magnets or magnetic grids are a simple magnetic system with a powerful magnetic field, consisting of a single layer of bars. They filter fine ferrous contaminants and weakly magnetic metals, such as processed stainless steel, as small as 30 µm from bulk flows and pipeline transport where there is limited installation height.

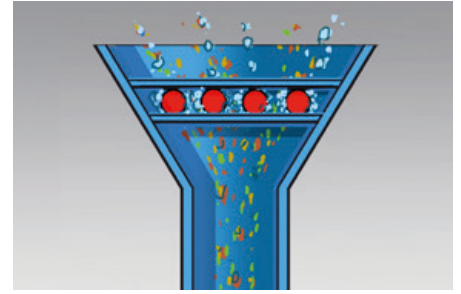

- For free-flowing granulates and powders.
- Free-fall pipeline / low installation height.
- Stainless steel separation possible.
- Ø 100 – 350 mm.
- Cleaning: manual, easy clean.



magnetic grids are very robust. They are available as standard in a number of square and round versions, with special dimensions on request.

The neodymium magnetic bars in our grids are enclosed in extractor tubes that eliminate the need for manual wiping.

By pulling the unit with the magnetic bars out of the extractor tubes, the captured metal contamination falls off the bars itself.

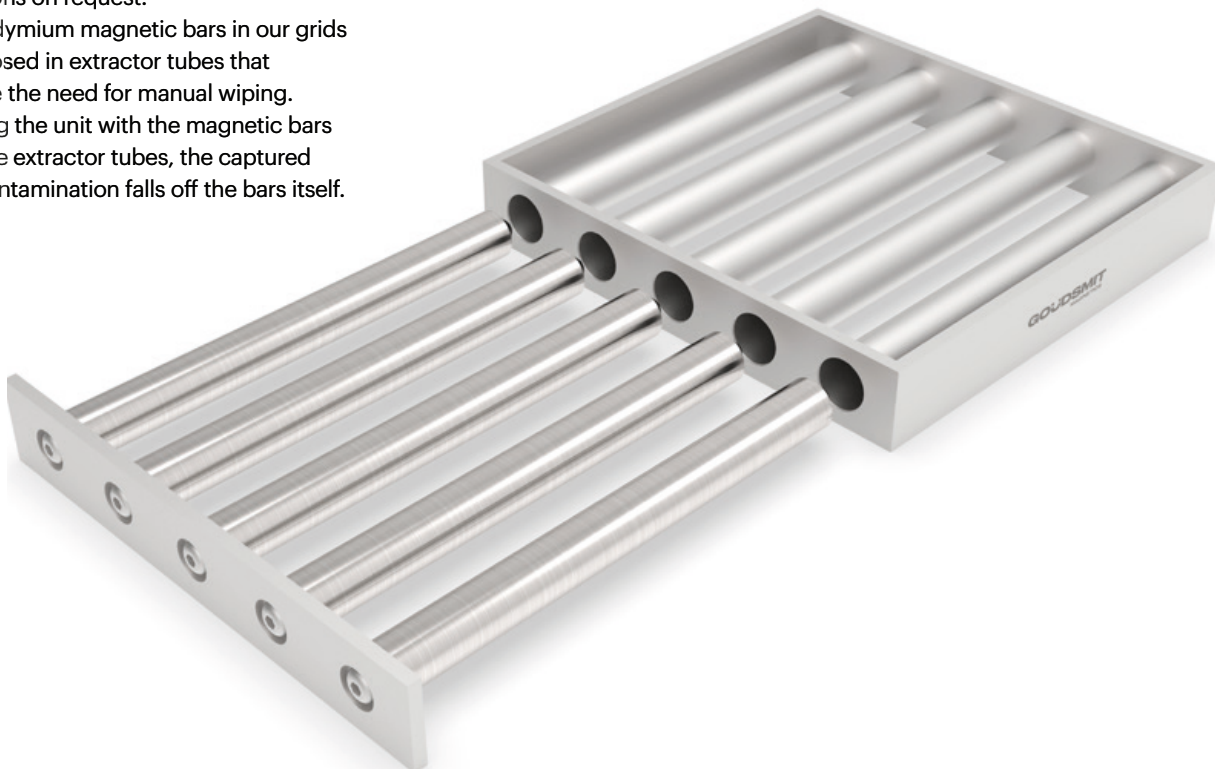

## Cleanflow magnets

For effective separation, we place two layers of powerful neodymium magnetic bars on top of each other, in a compact stainless steel housing; this is a Cleanflow magnet. It is fitted with an inspection hatch and an extractor for quick cleaning.

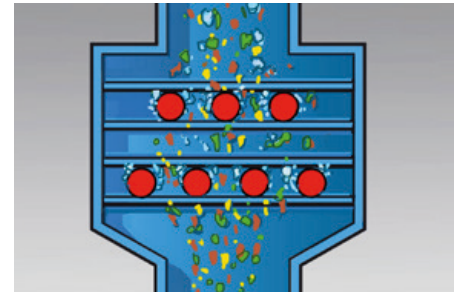
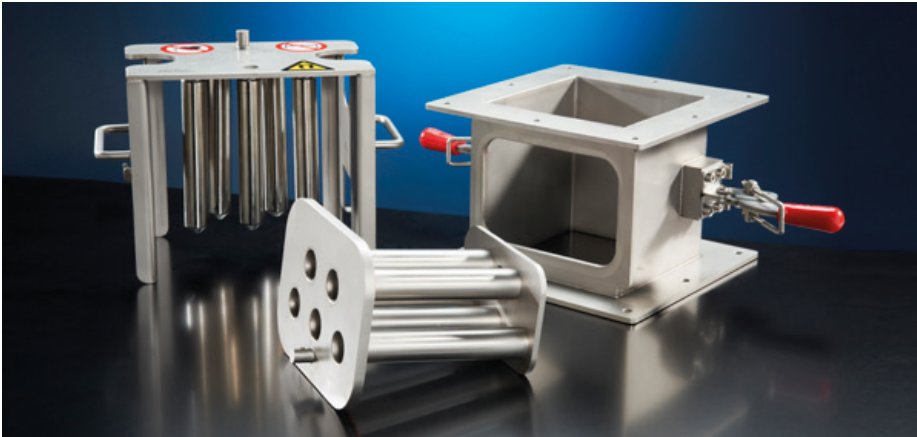

- For free-flowing granulates and powders.
- Free-fall pipeline.
- Stainless steel separation possible.
- Ø 150 – 400 mm.
- Cleaning: easy clean & automatic.

The bars are located at the centre of the product flow. This ensures that the product always passes very close to one or more magnets.

### Versions

Cleanflow magnets filter small ferrous contaminants and weakly magnetic materials, such as 304 stainless steel, as small as 30 µm from free-flowing, dry as well as fatty powders and bulk materials. They are available in pressure-tight, dust-proof and hygienic versions and for capacities from 2 to 90 m<sup>3</sup>/h.

## Static Cleanflow magnets

Static Cleanflow magnetic separators are suitable for free-flowing products. They have one row of thick magnetic bars, or two rows of thin ones, staggered one above the other.



Easy Clean Cleanflow magnet in cleaning position

### Static Cleanflow magnets

Dimensions Ø mm	Capacity [m <sup>3</sup> /h] good flowing product (approx.)
100	2
150	4
200	10
250	20
300	30
350	40

Bars Ø 50; 2x higher

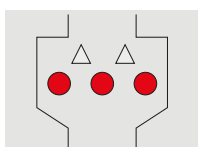

Automatic cleaning Easy Clean Cleanflow magnet



## Rotating Cleanflow magnets

Rotating Cleanflow magnets are suitable for products that flow poorly – because they are sticky or greasy, for example – as a result of which bridging and accumulation may occur. The rotating movement of the magnets prevents bridging and accumulation and improves contact between magnet and product. The result is better separation and higher capacity.

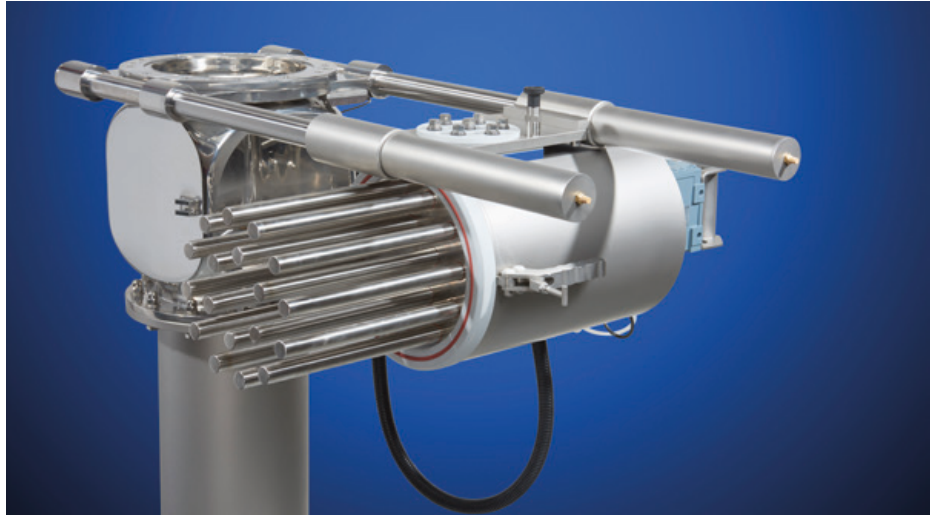

### Rotating Cleanflow magnets

Dimensions [mm <sup>2</sup> ]	Design	Capacity [m <sup>3</sup> /h] (approx.)
200	6-rod	9
300	8-rod	22
300	12-rod	14
520 x 300	2x 8 rod	45
520 x 300	2x 12 rod	36

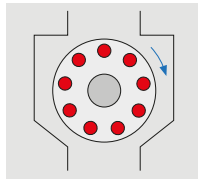

## Cleaning of Cleanflow magnets

### Manual quick cleaning

Magnetic bars are fitted with enveloping extractor tubes, which makes cleaning easier. By pulling the magnetic bars out of the extractor tubes, the captured metal contamination falls off the bars itself.

### Semi-automatic – Easy Clean cleaning

With this system, the operator manually pulls the magnet unit out of the housing via a side guide, after which the magnets are automatically blown into the tube outside the product flow. As a result, the iron automatically falls off the tubes.

Semi-automatic cleaning has big

### Easy Clean Cleanflow magnets

Dimensions [mm <sup>2</sup> ]	Capacity [m <sup>3</sup> /h] good flowing product (approx.)
200	40
300	60
400	90



advantages: the magnetic field strength at the pipe is considerably higher. This is important for capturing 316 stainless steel particles. Moreover, no product comes between the magnetic bar and the extractor tube.

### Automatic cleaning

With this system, an electrical signal moves the magnets outwards, after which automatic cleaning takes place. This signal can come from a control on the machine or in a control room. Automatic cleaning is possible with and without a production stop.

## Magnetic filters for liquids and powders under pressure

Powerful magnetic filters remove iron and weakly magnetic particles as small as 30 µm from liquids and powders transported under pressure.

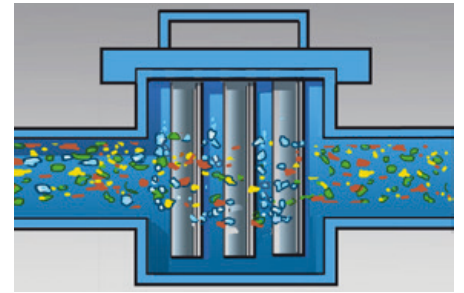

- For liquids, powders and granulates.
- Pressure transport.
- Stainless steel separation possible, in part.
- DN50 – DN400.
- Cleaning: easy cleaning.

The applications are numerous; every industry has its own requirements, but the principle remains the same. The powerful Neoflux® (Nd-Fe-B) magnetic bars penetrate deep into the product. This allows them to capture even the smallest metal particles, from 30 µm to 2 mm, and even very fine stainless steel. These particles are so small that they cannot even be detected by a metal detector.

### Design

Magnetic filters are fitted with several magnetic bars, staggered one above the other. With this arrangement, a product always touches the magnetic bars and the magnet extracts even the finest iron particles from sticky substances such as chocolate, pastes, powders and fruit juices. Magnetic filters can be divided into three groups: industrial magnetic filters,

double-walled filters (often for chocolate) and EHEDG or hygienic filters.







### Industrial magnetic filters

The robust industrial filter is suitable for high pressure and can withstand extreme production conditions.

Typical applications are paper, printing ink and the chemical industry.

- For transport under pressure, max. 10 bar / 60 °C
- Also removes large Fe particles, from 1 to 50 mm
- Manual cleaning (quick cleaning)

#### Industrial magnetic filter

Type number	Pipe Ø [mm]	Number of bars	Installation length [mm]
SFN-050	DN50	4	230
SFN-065	DN65	4	230
SFN-080	DN80	7	300
SFN-100	DN100	7	300
SFN-125	DN125	7	300
SFNG-150	DN150	9	410
SFNG-200	DN200	11	460

### Double-walled magnetic filters with heating jacket

Double-walled magnetic filters remove iron particles as small as 30 µm from products such as liquid chocolate. The product remains in liquid form due to hot water in the outer wall. An integrated sieve that removes other contaminants, such as paper, plastic or stones, from the product is available as an option. The magnetic filter is made of 316 stainless steel and is easy to implement in an existing 10 bar pressure pipeline. Seals meet the requirements of EC1935/2004. The magnetic filter is available for pipe sizes from DN50 to DN125. The sieve is one of the options.

#### Double-walled magnetic filter

Type number	Pipe Ø [mm]	Number of bars	Installation length [mm]
SFND-050	DN50	5	300
SFND-065	DN65	5	300
SFND-080	DN80	7	360
SFND-100	DN100	7	360





## EHEDG magnetic filters



Filter with manual quick cleaning

## EHEDG filter with CIP cleaning



EHEDG filter with pneumatically operated bar for CIP cleaning

## Sanitary magnetic filters



Sanitary filter with manual quick cleaning

This hygienic magnetic filter has been specially designed for the food and pharma industries in accordance with EHEDG specifications.

The filter is fitted with Neoflux® (neodymium) magnetic bars that provide effective separation of very fine Fe particles from 30 µm, weakly magnetic (stainless steel) particles and even iron dust from liquid and powdered products.

Available with manual or CIP cleaning. The entire system is compliant with the highest hygienic requirements in connection with food safety.

### EHEDG-compliant magnetic filter

Type number	Pipe Ø [mm]	Number of bars	Installation length [mm]
SFH-050	DN50	5	213
SFH-065	DN65	5	236
SFH-080	DN80	7	293
SFH-100	DN100	7	296
SFH-125	DN125	7	300

### EHEDG magnetic filter with CIP cleaning

Type number	Pipe Ø [mm]	Number of bars	Installation length [mm]
SFH-050-R	DN50	1	213
SFH-065-R	DN65	1	236
SFH-080-R	DN80	1	293
SFH-100-R	DN100	1	296

### Sanitary magnetic filter

Type number	Pipe Ø [mm]	Number of bars	Installation length [mm]
SFM-050	DN50	3	313
SFM-065	DN65	3	323
SFM-080	DN80	4	366
SFM-100	DN100	5	508
SFM-125	DN125	7	640

# Magnetic plate systems

Plate systems have a deep magnetic field for capturing large quantities of iron particles with a minimum size of 1 mm from coarser, free-flowing materials. These are suitable for pipeline transport and free-fall systems.

## Plate magnets

Plate magnets remove iron particles from various product flows, such as those in the plastics, wood, stone, ceramic and food industries. There are many installation options, including hanging above the conveyor (type A) or against/under the wall of a pipeline (type B). At a general rule, the closer the magnet is to the product, the more effective the iron separation is.

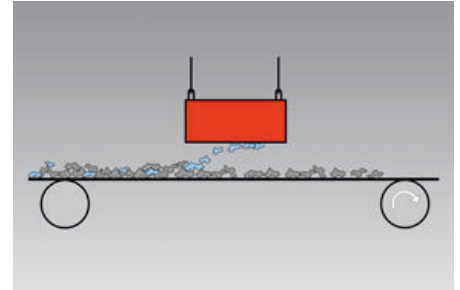

- For free-flowing powders and granulates.
- Free-fall pipeline and belt transport.
- Stainless steel separation not possible.
- L = 140 – 2,000 mm.
- Cleaning: manual.

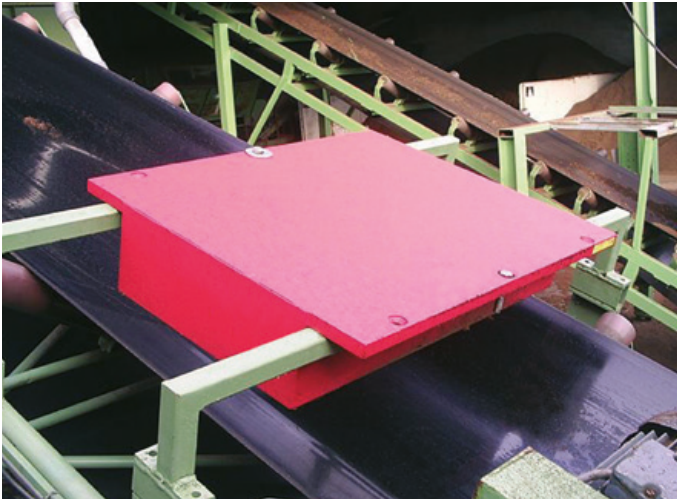

Type A

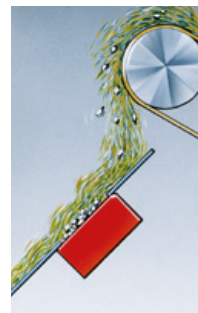

Type B

## Ferrite plate magnets

- Cost effective
- Heavy in weight
- Good penetration strength (up to 400 mm)
- Suitable for up to approx. 250 °C
- Field strength at magnetic poles: 2,800 gauss
- Not suitable for capturing stainless steel scrapings
- Applications: agro, feed, recycling industries
- Cleaning: manual (by wiping off) – use safety gloves

### Plate magnets ferrite

Type number	W-H mm	Holding field	Length mm (max.)
VMF1	114 x 47	65	1,000
VMF2	154 x 47	75	1,000
VMF4	204 x 92	110	1,500
VMF5	304 x 99	140	1,500



## Neoflux® (Nd-Fe-B) plate magnets



- 4x more powerful than ferrite magnets
- More temperature sensitive
- Light and compact
- Standard version suitable for up to 60 °C
- Special version for up to 140 °C
- Field strength at magnetic poles max. 8,000 gauss at the keyway
- Version: entirely stainless steel; waterproof (IP67)
- Supplied in quick-cleaning version (with stainless steel protection plate)
- Suitable for the food industry

### Plate magnets neodymium

Type number	W-H mm	Holding field	Length mm (max.)
VMN6	114 x 34	80	1,000
VMN2	205 x 55	180	1,500
VMN3	158 x 32	50	1,000

## Chute magnets

If you just order a plate magnet, the assembly, sealing and cleaning solution are your responsibility. A chute magnet however, is a plate magnet that includes an installation set consisting of a mounting plate, seal and extractor plate for quick cleaning.

This magnet removes iron particles from 1 mm to about 5 mm. It is easy to install. Once you have received the parts, attach the mounting plate to the chute (weld or use bolts), and then hang the magnet inside. For lengths exceeding 400 mm, the weight becomes an issue.

For those situations, we make units with pneumatic cylinders for automatic cleaning of the magnet.

Chute magnets can be used for powder flows in free fall or in chutes. The angle of the chute may not exceed 45° from the vertical.

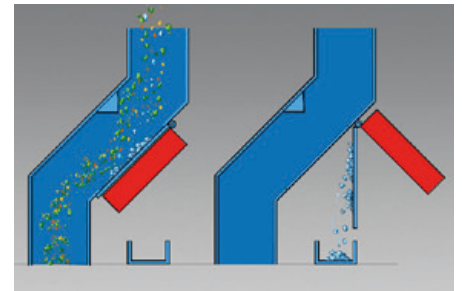

- For free-flowing powders and granulates.
- Free-fall transport.
- Stainless steel separation not possible.
- L = 250 – 800 mm.
- Cleaning: easy clean, automatic.



Chutemagnet in sugar production before product inlet

### Cleaning

Cleaning of the chute magnet – plate magnet with extractor plate – is done semi-automatically.

With this system, you can turn the extractor plate away from the magnet. The iron particles fall off of the extractor plate as soon as they are moved far enough away from the magnet.



## Cascade magnets

Cascade magnets filter ferromagnetic (Fe) metal contaminants out of granulates, fibres and coarser materials in high capacity free-fall pipelines.

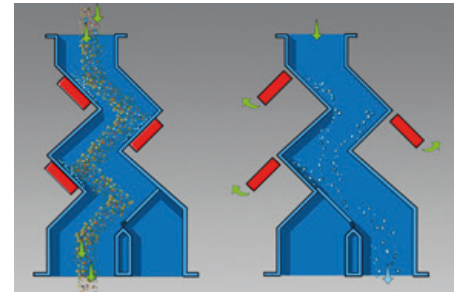
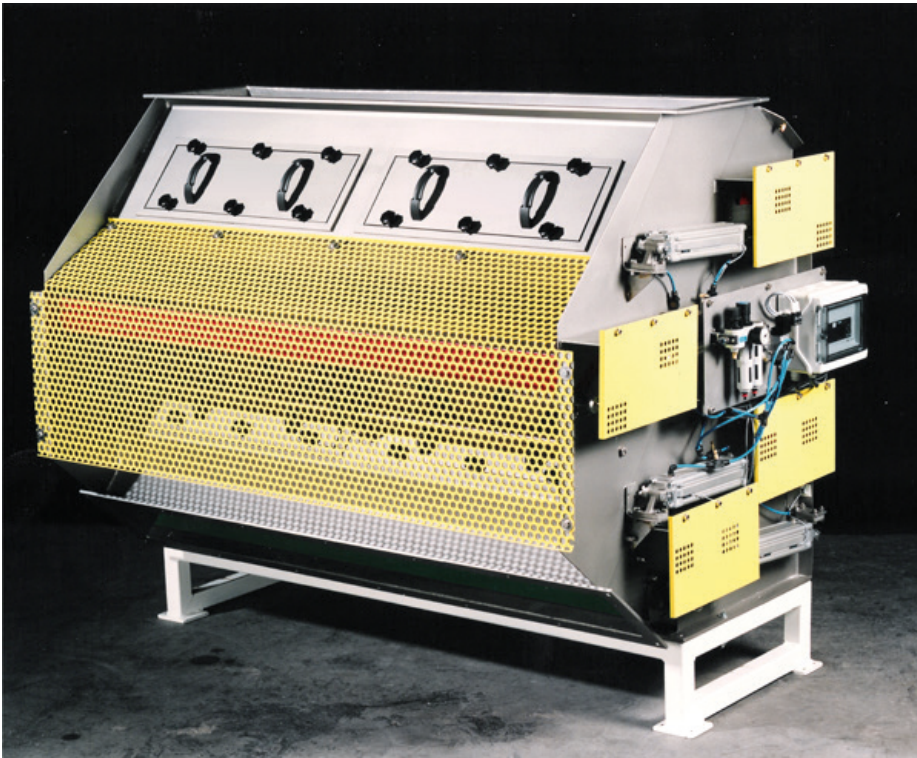

- For free-flowing powders and granulates.
- Free-fall transport.
- Stainless steel separation not possible.
- L = 400 – 1,500 mm.
- Cleaning: automatic.

These robust magnets can be used in the bulk, feed, plastics and ceramics industries. A cascade magnet can handle high capacities because the plate magnets

are located along the outside, against the product chute, allowing the product to fall freely between them.

### Design

With the robust pneumatic cleaning cascade magnets, the last magnet is neodymium as standard, in order to attain even better separation yield.

### Cascade magnets

Type number	Inlet/outlet [mm]	Installation height [mm]	Capacity [m <sup>3</sup> /h]
SRKP040035	400 x 200	885	50
SRKP060035	600 x 200	885	90
SRKP080035	800 x 200	885	140
SRKP100035	1,000 x 30	1,165	200
SRKP125035	1,250 x 30	1,165	240
SRKP150035	1,500 x 30	1,165	300



## Magnetic sweepers

magnetic sweepers for removing sharp metal parts from festival grounds, campsites and other outdoor areas.

Magnetics supplies manually operated magnetic sweepers for work-shops, warehouses and other areas where pieces of metal are left behind.



Magnetic sweeper for outdoor use, such as festival grounds



Manually operated magnetic sweeper for indoor use

## External pole magnets

External pole magnets filter unwanted iron and steel particles in the 0.5 to 50 mm range from powders and granulates in free-fall pipelines. They are used in the bulk, feed, plastics, ceramics and recycling industries, among others. External pole magnets are very robust.

An advantage is that the magnets are outside the product chute and the product can therefore fall freely through it. This allows them to handle high capacities and only minimal bridging occurs.

### Design

Two magnetic plates are located opposite each other, outside the product chute. They have a deep, powerful holding field. This enables them to capture Fe particles from the product flow.

external pole magnets are fitted with extractor plates, for quick, easy cleaning.

- Versions: with either ferrite or neodymium (Neoflux®) magnets
- Cleaning: manual or automatic

The capacity of the external pole magnet is max. 200 m<sup>3</sup>/h.

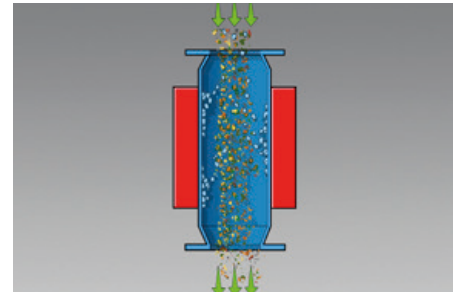

- For poorly flowing powders and granulates.
- Free-fall transport.
- Stainless steel separation not possible.
- Ø 180 – 350 mm.
- Cleaning: easy clean, automatic.

## External pole magnet ferrite

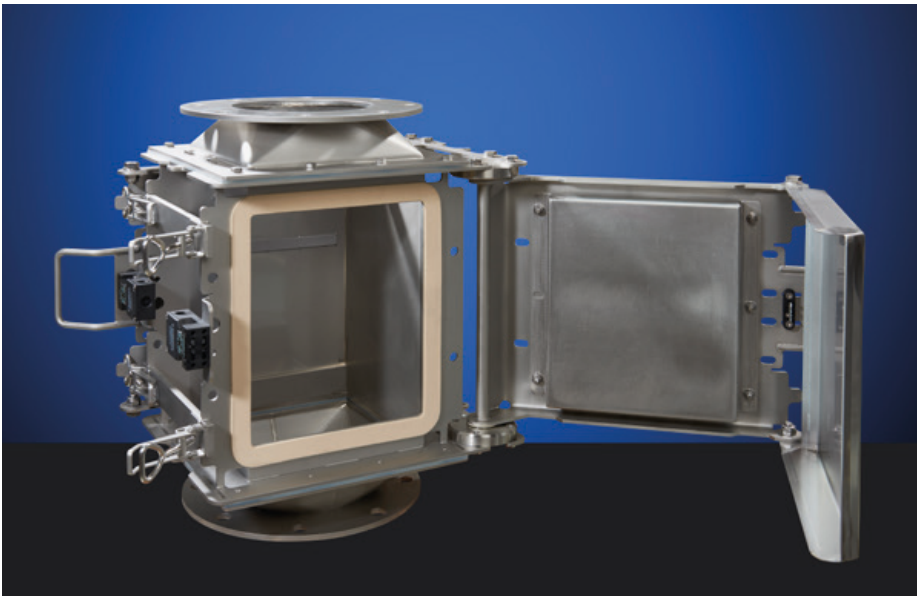

### External pole magnets ferrite

Type number	Inlet/outlet [mm <sup>2</sup> ]	Capacity [m <sup>3</sup> /h]
SBPF180001	180	50
SBPF260001	260	100
SBBF360001	360	200

## External pole magnet neodymium



### External pole magnets neodymium

Type number	Inlet/outlet [mm <sup>2</sup> ]	Capacity [m <sup>3</sup> /h]
SBPN100000	150	40
SBPN150000	200	75
SBPN200000	250	100
SBPN250000	300	140
SBPN252500	300	140
SBPN353500	350	190



# Magnetic cylinder systems

Cylinder magnet systems are a combination of bar and plate magnets. Can be made with either a deep magnetic field or a powerful, intense field. Suitable for both very fine (from 30 µm) and very large pieces (up to approx. 80 mm), depending on the choice of magnet.

## Bullet magnets

Permanent and electromagnetic bullet magnets remove iron particles as small as 50 µm from granular and powdered materials in free-fall pipelines. As such, they prevent damage to injection moulding machines, extruders, mixers, grinders and other equipment.

Moreover, these magnets improve the quality of your finished product, protect your valuable installations and prevent dust explosions.

### Application

in the animal feed, plastics, chemical, sand and cement industries as well as the ceramic and recycling industry.

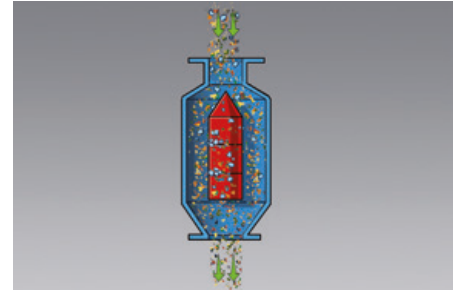

- For free-flowing powders and granulates.
- Free-fall and pneumatic transport.
- Stainless steel separation not possible.
- Ø 100 – 600 mm.
- Cleaning: manual & automatic.



Bullet magnet for ceramic material

### Permanent bullet magnets

Type number	Inlet/outlet [mm]	Installation height [mm]	Capacity [m³/h]
SPPE000160	100	570	10
SPPE000161	150	680	28
SPPE000162	200	792	60
SPPE000063	250	950	100
SPPE000064	300	1,000	140
SPPE000065	400	1,100	250
SPPE000066	500	1,200	380
SPPE000067	600	1,300	550



An upside down mounted bullet magnet for plastic granulate



## Magnetic drum separators

Big advantages of the magnetic drum separators are the continuous cleaning and low installation height. They are particularly well suited for granular products. With fine powders, leakage can occur between the product chute and the Fe particle discharge.

They are available with various magnetic systems for capturing very coarse pieces (max. 80 mm) to very small particles > 30 µm. This makes them extremely suitable for removing large amounts of Fe particles from powders, granulate, fibres

and coarser materials with a lot of Fe contamination.

Depending on the requirements, four different magnetic systems are available (see website for more information).

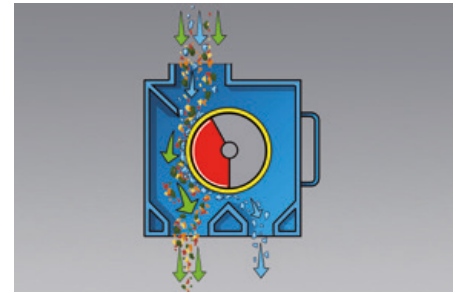

- For free-flowing powders and granulates.
- For free-fall transport.
- Stainless steel separation possible, in part.
- L = 400 – 2,000 mm.
- Cleaning: continuous, automatic.

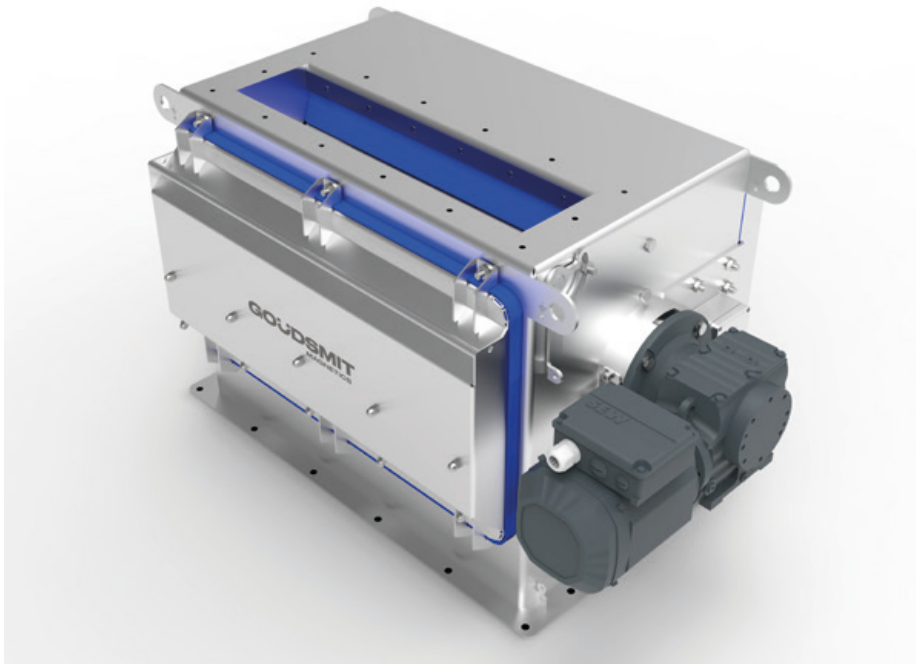

### Magnetic drum separator, ferrite

Type number	Inlet [mm]	Height [mm]	Capacity [m <sup>3</sup> /h]
SETK-043-SD	400 x 150	500	35
SETK-063-SD	600 x 150	500	52
SETK-084-SD	800 x 200	650	120
SETK-105-SD	1,000 x 250	775	180
SETK-125-SD	1,200 x 250	775	215
SETK-145-SD	1,400 x 250	775	250
SETK-165-SD	1,600 x 250	775	300
SETK-205-SD	2,000 x 250	775	400

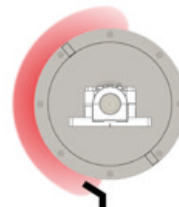

Fe particles from  
3 - 15 mm

### Magnetic drum separator neodymium power supply

Type number	Inlet [mm]	Height [mm]	Capacity [m <sup>3</sup> /h]
SETK-043-SC-B	400 x 120	595	32
SETK-063-SC-B	600 x 120	595	47
SETK-083-SC-B	800 x 120	595	100
SETK-103-SC-B	1,000 x 120	595	160



Fe particles from  
1 - 5 mm

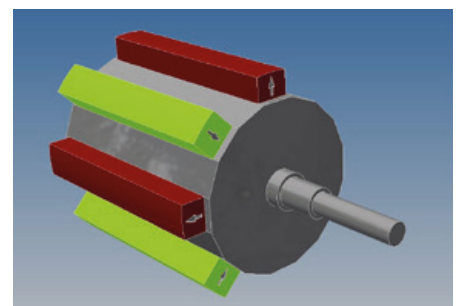

**Magnetic drum separator neodymium power supply, extra strong**

Type number	Inlet [mm]	Height [mm]	Capacity [m <sup>3</sup> /h]
SETK-043-SC-P	400 x 120	595	20
SETK-063-SC-P	600 x 120	595	32
SETK-083-SC-P	800 x 120	595	50
SETK-103-SC-P	1,000 x 120	595	80

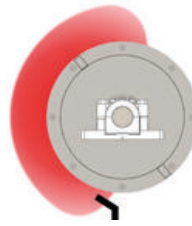

Fe particles from 0.1 - 3 mm

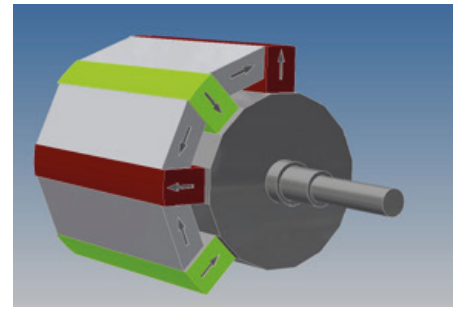

**Magnetic drum separator neodymium power supply, high intensity**

Type number	Inlet [mm]	Height [mm]	Capacity [m <sup>3</sup> /h]
SETK-043-SC-H	400 x 120	595	15
SETK-063-SC-H	600 x 120	595	25
SETK-083-SC-H	800 x 120	595	35
SETK-103-SC-H	1,000 x 120	595	50



Fe and stainless steel particles from 0.05 - 3 mm

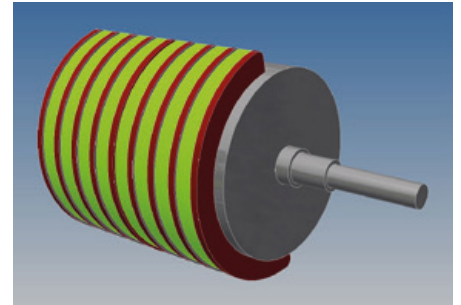

**High-gradient separators**

These separators consist of a conveyor belt with an extremely strong magnetic head pulley at the end. The product is finely distributed on the belt by means of a vibratory feeder to achieve optimal contact between the product and the magnetic conveyor roller. This results in very good separation of both very small and weakly magnetic particles.

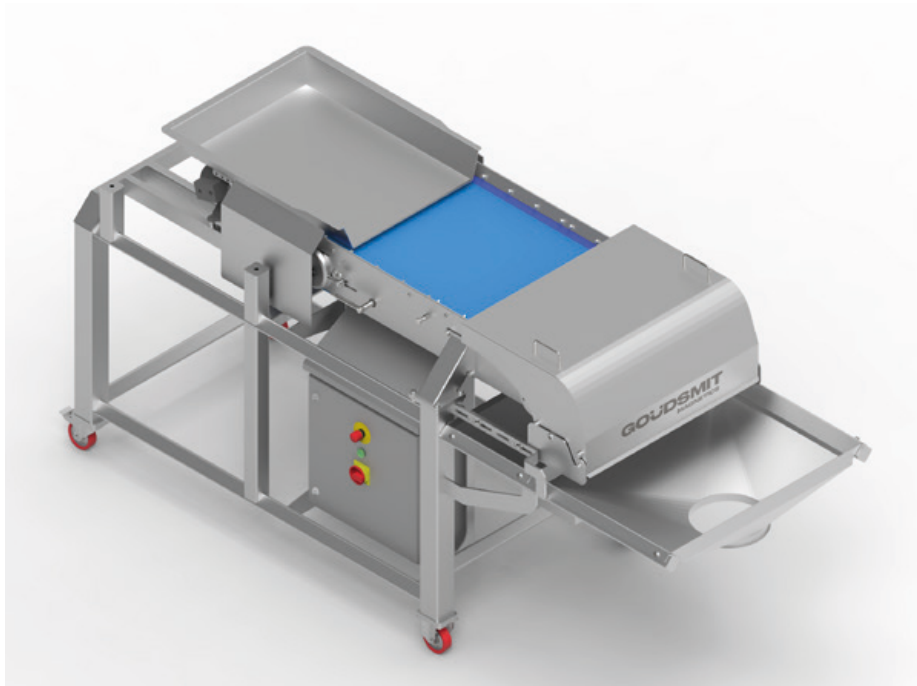
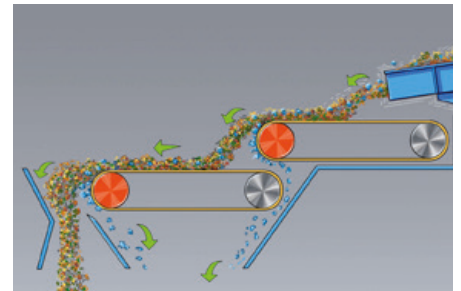

- For free-flowing powders and granulates.
- For belt transport.
- Stainless steel separation possible.
- G = 400 x 1,000 mm.
- Cleaning: continuous, automatic.

**Application**

HG separators are suitable for granular products that do not stick to the belt. For example, to remove magnetic particles from coffee or to separate pellets that contain a small amount of Fe contamination. A very special application is the separation from seeds.

