



# Pharma Hygiene Products

## PRODUCT GUIDE



**QUILINOX**<sup>®</sup>  
ALL ABOUT FLUIDS



902 304 316

[quilinox@quilinox.com](mailto:quilinox@quilinox.com)

[www.quilinox.com](http://www.quilinox.com)







## About us

We are a leading supplier of high quality stainless steel process equipment ranging from standard buckets and beakers, to mixing and storage containers and custom designed bespoke vessels. All are made to pharmaceutical standards in 304 and 316L grade stainless steel, and are suitable for use in production areas, laboratories and kitchens, particularly where the highest standards of hygiene are required.

## Quality Guarantee

Our customers operate to exacting standards, and our products must meet the highest standards of hygiene and reliability, whatever the production environment. All our products are manufactured from FDA approved materials, and are fully certified where required.

## Sustainability

At PHP we take our environmental responsibilities very seriously. We strive to ensure that every aspect of our supply chain meets the exacting standards of our environmental policy.

## Practical Advice

Our experienced and knowledgeable support team are waiting to help you, and are available Monday to Friday, between 9am and 5pm. They know our product range inside out, so can pinpoint the exact part you need or find the right solution to meet your requirements.

## Pharma Hygiene Products

+44 (0)1444 472300

info@pharmahygieneproducts.com

www.pharmahygieneproducts.com

Olympus House • Mill Green Road  
Haywards Heath • West Sussex  
RH16 1XQ • UK



Pharma Hygiene Products Ltd  
is part of the Adelphi Group  
of Companies

# Contents

## 1 Storage, mixing and transport

Mixing and storage containers, mobile frames, cans with lids, churns, buckets and pails, containers with lids, bowls and basins, trays, jacketed vessels, pressure vessels and polypropylene vessels

## 8 Mixers and agitators

Mobile mixers, integrated mixers and agitators

## 9 Measuring and pouring

Jugs, strainers, funnels and beakers

## 12 Utensils

Scoops, ladles, whisks, spatulas, scrapers, paddle stirrers

## 14 Hospital and healthcare

Instrument boxes, thermometer/tong jars and kidney dishes

## 15 Customised process equipment

Bespoke vessels to suit a range of applications

## 16 Pharmaceutical dispensing

Tablet and capsule counters, capsule fillers, suppository and pessary moulds

## 19 Optional modifications (fitted)

Toggle clamps, graduations, etching, mobile frames, butterfly and ball valves, taps, bibs, hose connectors, pouring spouts, handles, O-ring seals, lid holes and skirt band removal

## 22 Tri-Clamp fittings

Ball valves, butterfly valves, blank caps, butterfly valve gasket seals, clamps, concentric reducers, elbows, equal tees, ferrule ends and gaskets, straight pipes and hose tail connectors

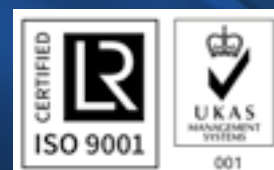

Pharma Hygiene Products offer a wide range of standard storage, mixing and transport vessels, from small bowls up to larger 200 litre tanks.

## Mixing and storage containers

Manufactured from 316L and 304 grade stainless steel, these containers can be supplied either plain or graduated and come complete with side handles and skirtband. They have crevice- and pit-free interiors and are polished throughout. An optional lid is available for all sizes, and most can be integrated with a mixer.

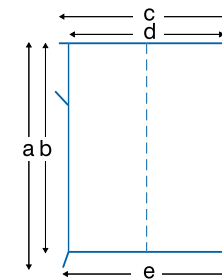

Please also see our **Customised Process Equipment** section on page 15 for more bespoke solutions.

| Item code | Capacity (litres) | a   | b   | c   | d   | e   | Skirt | Handle | Grad.     | Weight (kg) | Lid code | Lid weight (kg) |
|-----------|-------------------|-----|-----|-----|-----|-----|-------|--------|-----------|-------------|----------|-----------------|
| VES4020P  | 20                | 390 | 380 | 350 | 265 | 275 | YES   | SIDE   | -         | 3.4         | VEL4020P | 0.6             |
| VES*020G  | 20                | 390 | 380 | 350 | 265 | 275 | YES   | SIDE   | 5-20/5    | 3.4         | VEL*020P | 0.6             |
| VES4025P  | 25                | 390 | 380 | 380 | 300 | 305 | YES   | SIDE   | -         | 3.8         | VEL4025P | 0.8             |
| VES*025G  | 25                | 390 | 380 | 380 | 300 | 305 | YES   | SIDE   | 5-25/5    | 3.8         | VEL*025P | 0.8             |
| VES4030P  | 30                | 460 | 445 | 380 | 300 | 305 | YES   | SIDE   | -         | 4.4         | VEL4030P | 0.8             |
| VES*030G  | 30                | 460 | 445 | 380 | 300 | 305 | YES   | SIDE   | 5-30/5    | 4.4         | VEL*030P | 0.8             |
| VES4050P  | 50                | 560 | 535 | 435 | 350 | 355 | YES   | SIDE   | -         | 6.4         | VEL4050P | 1               |
| VES*050G  | 50                | 560 | 535 | 435 | 350 | 355 | YES   | SIDE   | 5-50/5    | 6.4         | VEL*050P | 1               |
| VES4075P  | 75                | 625 | 600 | 480 | 400 | 405 | YES   | SIDE   | -         | 8.5         | VEL4075P | 1.3             |
| VES*075G  | 75                | 625 | 600 | 480 | 400 | 405 | YES   | SIDE   | 5-75/5    | 8.5         | VEL*075P | 1.3             |
| VES4100P  | 100               | 675 | 650 | 520 | 445 | 455 | YES   | SIDE   | -         | 12          | VEL4100P | 1.6             |
| VES*100G  | 100               | 675 | 650 | 520 | 445 | 455 | YES   | SIDE   | 10-100/10 | 12          | VEL*100P | 1.6             |
| VES4150P  | 150               | 675 | 650 | 620 | 550 | 555 | YES   | SIDE   | -         | 16          | VEL4150P | 2.3             |
| VES*150G  | 150               | 675 | 650 | 620 | 550 | 555 | YES   | SIDE   | 10-150/10 | 16          | VEL*150P | 2.3             |
| VES6240P  | 240               | 890 | 850 | 730 | 600 | 625 | YES   | SIDE   | -         | 26          | VEL6240S | 3               |

**Notes:** 1. Graduations: 5-20/5 = graduated from 5 litres to 20 litres in 5 litre intervals.  
2. In the data table, replace the \* with 4 if 304 grade is required, or with 6 if 316L grade is required.  
3. Where no \* occurs in the item code, material is 304 grade.

**Options:** (see key to symbols on pp 19-20)

## Mobile frames

Manufactured from 304 grade stainless steel, these mobile frames are ideal for moving our mixing and storage vessels smoothly and safely, without lifting or carrying. Supplied with four castors, two with brakes, they are available with straight or angled locating flanges.



| Item code | Suit vessel capacity (litres) |
|-----------|-------------------------------|
| FRA4020*  | 20                            |
| FRA4025*  | 25                            |
| FRA4030*  | 30                            |
| FRA4050*  | 50                            |
| FRA4075*  | 75                            |
| FRA4100*  | 100                           |
| FRA4150*  | 150                           |
| FRA4200*  | 200                           |





### Cans with lids

Manufactured from either 304 or 316L grade stainless steel, these cans come complete with lids and swing handles. They have crevice- and pit-free interiors and are polished throughout.

**Note:** In the data table replace \* with 4 if 304 grade is required, or with 6 if 316L grade is required.

**Options:**



(see key to symbols on pp 19–20)



| Item code | Capacity (litres) | a   | b   | c   | d   | e   | Skirt | Handle | Weight (kg) |
|-----------|-------------------|-----|-----|-----|-----|-----|-------|--------|-------------|
| CWL*001P  | 1                 | 155 | 150 | 125 | 100 | N/A | NO    | SWING  | 0.4         |
| CWL*002P  | 2                 | 175 | 170 | 160 | 130 | N/A | NO    | SWING  | 0.7         |
| CWL*003P  | 3                 | 185 | 180 | 185 | 155 | N/A | NO    | SWING  | 1           |
| CWL*004P  | 4                 | 200 | 185 | 186 | 170 | 173 | YES   | SWING  | 1.3         |
| CWL*005P  | 5                 | 240 | 230 | 205 | 175 | 180 | YES   | SWING  | 1.4         |
| CWL*006P  | 6                 | 280 | 270 | 205 | 175 | 180 | YES   | SWING  | 1.7         |
| CWL*008P  | 8                 | 285 | 270 | 235 | 200 | 205 | YES   | SWING  | 2           |
| CWL*010P  | 10                | 295 | 280 | 250 | 220 | 225 | YES   | SWING  | 2.5         |

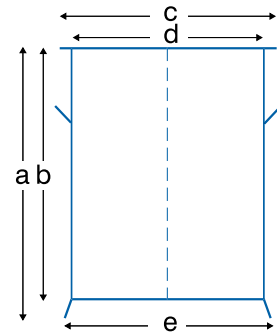

### Churns

#### (A) Chemical churns



Manufactured from 316L grade stainless steel, these churns are specially designed for the storage and transportation of antibiotics and chemicals. They come complete with side carrying handles, skirtband and lid (secured by toggle clamps and a Viton® seal). They have crevice- and pit-free interiors and are polished throughout.

| Item code | Capacity (litres) | a   | b   | c  | d   | e   | Skirt | Handle | Weight (kg) |
|-----------|-------------------|-----|-----|----|-----|-----|-------|--------|-------------|
| CHU6015P  | 15                | 425 | 240 | 30 | 160 | 245 | YES   | SIDE   | 4.2         |
| CHU6030P  | 30                | 530 | 300 | 30 | 200 | 300 | YES   | SIDE   | 7           |
| CHU6040P  | 40                | 590 | 300 | 30 | 200 | 360 | YES   | SIDE   | 8           |
| CHU6050P  | 50                | 700 | 400 | 30 | 200 | 360 | YES   | SIDE   | 9           |



**A** Chemical churns  
**B** Churns with swing handles  
**C** Churns with side handles  
**D** Churns with spout

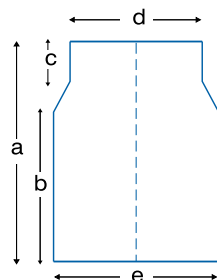

#### (B) Churns with swing handles



| Item code | Capacity (litres) | a   | b   | c  | d   | e   | Skirt | Handle | Weight (kg) |
|-----------|-------------------|-----|-----|----|-----|-----|-------|--------|-------------|
| CHU4003P  | 3                 | 215 | 150 | 40 | 120 | 155 | NO    | SWING  | 0.9         |
| CHU4005P  | 5                 | 265 | 190 | 40 | 140 | 175 | NO    | SWING  | 1.3         |
| CHU4010P  | 10                | 330 | 250 | 40 | 160 | 225 | YES   | SWING  | 2.7         |
| CHU4015P  | 15                | 370 | 280 | 50 | 200 | 275 | YES   | SWING  | 3.7         |
| CHU4020P  | 20                | 420 | 330 | 50 | 200 | 275 | YES   | SWING  | 4.1         |

Manufactured from 304 grade stainless steel, these churns come complete with a swing handle, skirtband and lid. They have crevice- and pit-free interiors and are polished throughout.

#### (C) Churns with side handles



| Item code | Capacity (litres) | a   | b   | c  | d   | e   | Skirt | Handle | Weight (kg) |
|-----------|-------------------|-----|-----|----|-----|-----|-------|--------|-------------|
| CHU4025P  | 25                | 420 | 290 | 55 | 205 | 320 | YES   | SIDE   | 5           |
| CHU4030P  | 30                | 485 | 355 | 55 | 205 | 320 | YES   | SIDE   | 5.5         |
| CHU4040P  | 40                | 550 | 385 | 80 | 220 | 355 | YES   | SIDE   | 7.8         |
| CHU4050P  | 50                | 650 | 480 | 80 | 220 | 355 | YES   | SIDE   | 8.8         |

Manufactured from 304 grade stainless steel, these churns come complete with side carrying handles, skirtband and lid. They have crevice- and pit-free interiors and are polished throughout. On the 40 and 50 litre versions the lid is attached with a chain.

#### (D) Churns with spout



| Item code | Capacity (litres) | a   | b   | c  | d   | e   | Skirt | Handle | Weight (kg) |
|-----------|-------------------|-----|-----|----|-----|-----|-------|--------|-------------|
| CHU4005S  | 5                 | 265 | 190 | 40 | 140 | 175 | YES   | SWING  | 1.6         |
| CHU4010S  | 10                | 330 | 250 | 40 | 160 | 225 | YES   | SWING  | 2.7         |
| CHU4015S  | 15                | 370 | 280 | 40 | 200 | 275 | YES   | SWING  | 3.7         |
| CHU4020S  | 20                | 420 | 330 | 50 | 200 | 275 | YES   | SWING  | 4.1         |

Manufactured from 304 grade stainless steel, these churns come complete with swing handle, bottom steadying handle, skirtband, pouring spout and lid. They have crevice- and pit-free interiors and are polished throughout.

**Options (all churns):**



(see key to symbols on pp 19–20)



## Buckets and pails

### (A) Buckets

Manufactured from 304 grade stainless steel with one size available in 316 stainless steel, these buckets are polished throughout, graduated in 1 litre intervals and come complete with swing handle. Skirtbands are standard as shown. Buckets without a skirtband are available to special order. Lids are available as an option.

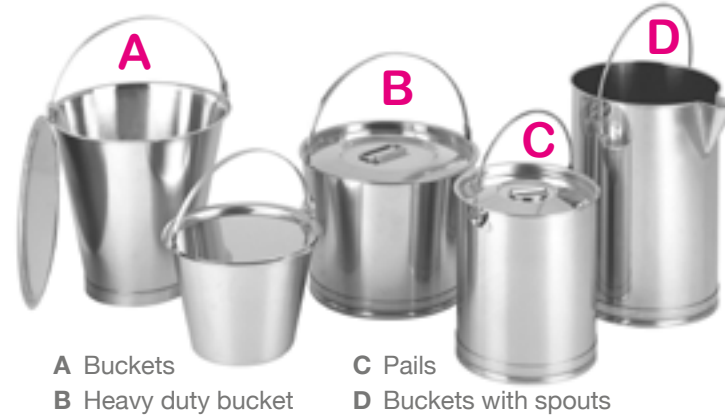

| Item code | Capacity (litres) | a   | b   | c   | Skirt | Handle | Grad.  | Weight (Kg) | Lid Code | Lid Weight (kg) |
|-----------|-------------------|-----|-----|-----|-------|--------|--------|-------------|----------|-----------------|
| BUC4007P  | 7                 | 240 | 160 | 250 | No    | Swing  | N/A    | 1           | BUL4007P | 0.4             |
| BUC4008G  | 8                 | 285 | 200 | 200 | No    | Swing  | 1-8/1  | 1.05        | BUL4008P | 0.55            |
| BUC4010G  | 10                | 295 | 175 | 270 | YES   | SWING  | 1-10/1 | 1.4         | BUL4010P | 0.4             |
| BUC4012G  | 12                | 320 | 210 | 260 | YES   | SWING  | 2-12/1 | 1.6         | BUL4012P | 0.5             |
| BUC6012G  | 12                | 320 | 210 | 260 | YES   | SWING  | 2-12/1 | 1.6         | BUL4012P | 0.5             |
| BUC4015G  | 15                | 325 | 202 | 340 | YES   | SWING  | 2-15/1 | 1.8         | BUL4015P | 0.6             |

### (B) Heavy duty bucket

Manufactured from 304 grade stainless steel, this bucket is designed for heavy duty applications. It comes complete with

a skirtband and swing handle and is graduated. Interiors are crevice- and pit-free and it is polished throughout.

| Item code | Capacity (litres) | a   | b   | c   | d   | e   | Skirt | Handle | Grad.  | Weight (kg) |
|-----------|-------------------|-----|-----|-----|-----|-----|-------|--------|--------|-------------|
| BHD4015G  | 15                | 255 | 240 | 340 | 320 | 295 | YES   | SWING  | 2-15/1 | 2.7         |

### (C) Pails

Manufactured from either 304 or 316L grade stainless steel, these pails come complete with a skirtband and swing

handle. They have crevice- and pit-free interiors and are polished throughout. Lids are available as an option.

| Item code | Capacity (litres) | a   | b   | c   | d   | e   | Skirt | Handle | Grad. | Weight (kg) | Lid code | Lid weight (kg) |
|-----------|-------------------|-----|-----|-----|-----|-----|-------|--------|-------|-------------|----------|-----------------|
| PAI*010P  | 10                | 255 | 240 | 275 | 237 | 245 | YES   | SWING  | N/A   | 2.1         | PAL*010P | 0.5             |
| PAI*012P  | 12                | 283 | 273 | 275 | 237 | 245 | YES   | SWING  | N/A   | 2.5         | PAL*012P | 0.5             |
| PA*015P   | 15                | 285 | 275 | 305 | 267 | 275 | YES   | SWING  | N/A   | 2.8         | PAL*015P | 0.6             |

### (D) Buckets with spouts

Manufactured from 304 grade stainless steel, these straight sided buckets are graduated, come complete with pouring spout, swing handle, bottom steadying handle, and

skirtband. They have crevice- and pit-free interiors and are polished throughout. Lids that are extended to cover the spout are available as an option.

| Item code | Capacity (litres) | a   | b   | c   | d   | e   | Skirt | Handle | Grad.    | Weight (kg) | Lid code | Lid weight (kg) |
|-----------|-------------------|-----|-----|-----|-----|-----|-------|--------|----------|-------------|----------|-----------------|
| BUS4010G  | 10                | 275 | 265 | 297 | 237 | 245 | YES   | SWING  | 1-10/0.5 | 2.3         | BSL4010P | 0.5             |
| BUS4015G  | 15                | 308 | 295 | 320 | 267 | 272 | YES   | SWING  | 2-15/0.5 | 2.7         | BSL4015P | 0.6             |
| BUS4020G  | 20                | 395 | 380 | 328 | 267 | 272 | YES   | SWING  | 2-20/1   | 3.4         | BSL4020P | 0.6             |

**Note:** In the data tables replace the \* with 4 if 304 grade is required, or with 6 if 316L grade is required. **Options (all buckets and pails):**



(key to symbols on pp 19-20)

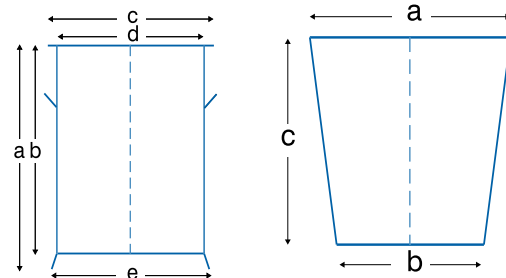

## Containers and lids

Manufactured from 304 grade stainless steel, these containers are available with an optional stainless steel lid. They have crevice- and pit-free interiors and are polished throughout.



| Item code | Capacity (ml) | Diameter (mm) | Depth (mm) | Weight (gm) | Lid code | Lid weight (gm) |
|-----------|---------------|---------------|------------|-------------|----------|-----------------|
| COC4060P  | 150           | 60            | 60         | 140         | COL4060P | 30              |
| COC4084P  | 250           | 85            | 50         | 175         | COL4085P | 60              |
| COC4085P  | 400           | 85            | 85         | 200         | COL4085P | 60              |
| COC4099P  | 300           | 100           | 50         | 200         | COL4100P | 75              |
| COC4100P  | 700           | 100           | 100        | 225         | COL4100P | 75              |
| COC4101P  | 1000          | 100           | 150        | 250         | COL4100P | 75              |
| COC4120P  | 1200          | 120           | 120        | 535         | COL4120P | 90              |
| COC4150P  | 2500          | 150           | 150        | 805         | COL4150P | 150             |
| COC4200P  | 6000          | 200           | 200        | 1560        | COL4200P | 250             |

**Options:** E (see key to symbols on pp 19-20)

## Bowls and basins

### (A) Standard conical bowls

Manufactured from 304 grade stainless steel, these bowls are pressed in one piece with a flat base and flat rim for ease of carrying. They are crevice- and pit-free and polished throughout.

| Item code | Capacity (litres) | a   | b   | c   | Weight (gm) |
|-----------|-------------------|-----|-----|-----|-------------|
| BOW40.1P  | 0.1               | 70  | 40  | 50  | 25          |
| BOW40.2P  | 0.2               | 100 | 60  | 50  | 50          |
| BOW40.3P  | 0.3               | 105 | 65  | 60  | 60          |
| BOW40.5P  | 0.5               | 130 | 75  | 70  | 95          |
| BOW4.75P  | 0.75              | 165 | 95  | 75  | 135         |
| BOW4001P  | 1                 | 170 | 95  | 90  | 140         |
| BOW41.5P  | 1.5               | 200 | 115 | 95  | 190         |
| BOW4002P  | 2                 | 220 | 110 | 120 | 240         |
| BOW42.5P  | 2.5               | 235 | 145 | 100 | 320         |
| BOW4003P  | 3                 | 250 | 140 | 120 | 345         |
| BOW4004P  | 4                 | 270 | 150 | 130 | 425         |
| BOW44.5P  | 4.5               | 285 | 175 | 120 | 460         |
| BOW4005P  | 5                 | 300 | 170 | 130 | 495         |
| BOW4006P  | 6                 | 320 | 190 | 145 | 575         |
| BOW4008P  | 8                 | 335 | 195 | 170 | 710         |
| BOW4009P  | 9                 | 340 | 195 | 180 | 710         |
| BOW4011P  | 11                | 395 | 210 | 180 | 950         |
| BOW4014P  | 14                | 410 | 210 | 195 | 1030        |

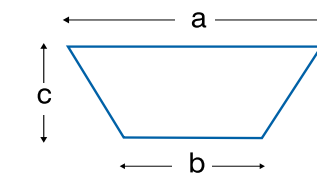

### (B) Shallow conical bowl

Manufactured from 304 grade stainless steel, this bowl is made in one piece with a flat base and flat rim for ease of carrying. It is crevice- and pit-free and polished throughout.

| Item code | Capacity (litres) | a   | b   | c  | Weight (gm) |
|-----------|-------------------|-----|-----|----|-------------|
| BOW4003L  | 3                 | 275 | 200 | 75 | 400         |



### (C) Lotion bowls

Manufactured from 304 grade stainless steel, these lotion bowls are supplied with a rolled top edge and flat base. They are crevice- and pit-free and polished throughout.

| Item code | Capacity (litres) | a   | b   | c   | Weight (gm) |
|-----------|-------------------|-----|-----|-----|-------------|
| LOB4120P  | 0.3               | 120 | 60  | 55  | 115         |
| LOB4140P  | 0.5               | 140 | 70  | 65  | 155         |
| LOB4180P  | 1                 | 180 | 90  | 75  | 260         |
| LOB4200P  | 1.5               | 200 | 100 | 80  | 290         |
| LOB4220P  | 2                 | 220 | 120 | 85  | 325         |
| LOB4240P  | 3.5               | 240 | 95  | 110 | 400         |

### (D) Wash basin

Manufactured from 304 grade stainless steel, this wash basin is supplied in one piece with a flat base and a rolled lip. It is crevice- and pit-free and polished throughout.

| Item code | Capacity (litres) | a   | b   | c  | Weight (gm) |
|-----------|-------------------|-----|-----|----|-------------|
| WAB4360P  | 3                 | 360 | 160 | 85 | 390         |

## Trays

### Shallow trays

Manufactured from 304 grade stainless steel, with several sizes available in 316L grade, these trays are supplied in one piece, with radiused corners. They are crevice- and pit-free, polished throughout, and have a rim approximately 10 mm wide.

| Item code | Length (mm) | Width (mm) | Depth (mm) | Weight (gm) |
|-----------|-------------|------------|------------|-------------|
| TRA4157S  | 157         | 162        | 10         | 165         |
| TRA4180S  | 180         | 120        | 10         | 177         |
| TRA4215S  | 215         | 160        | 10         | 214         |
| TRA4230S  | 230         | 162        | 10         | 240         |
| TRA4300S  | 300         | 200        | 10         | 404         |
| TRA4324S  | 325         | 317        | 10         | 665         |
| TRA4325S  | 325         | 265        | 10         | 550         |
| TRA4326S  | 325         | 143        | 10         | 300         |
| TRA4327S  | 325         | 234        | 10         | 495         |
| TRA4360S  | 360         | 240        | 10         | 629         |
| TRA4385S  | 385         | 210        | 10         | 706         |
| TRA4400S  | 400         | 270        | 10         | 706         |
| TRA4440S  | 440         | 325        | 10         | 1015        |
| TRA4451S  | 445         | 350        | 10         | 1059        |
| TRA4900S  | 490         | 320        | 19         | 1161        |
| TRA4495S  | 495         | 325        | 10         | 1000        |
| TRA4500S  | 500         | 162        | 10         | 530         |
| TRA4530S  | 530         | 325        | 10         | 1150        |
| TRA6290S  | 290         | 210        | 10         | 425         |
| TRA6320S  | 320         | 275        | 10         | 700         |
| TRA6415S  | 415         | 240        | 10         | 690         |



### Deep trays

Manufactured from 304 grade stainless steel, with several sizes available in 316L grade, these trays are supplied in one piece, with radiused corners. They are crevice- and pit-free and polished throughout.

| Item code | Length (mm) | Width (mm) | Depth (mm) | Weight (gm) |
|-----------|-------------|------------|------------|-------------|
| TRA4220D  | 220         | 150        | 45         | 310         |
| TRA4395D  | 395         | 280        | 70         | 1000        |
| TRA4450D  | 445         | 350        | 25         | 1135        |
| TRA4530D  | 530         | 325        | 100        | 2050        |
| TRA4531D  | 530         | 325        | 150        | 2375        |

**Note:** part codes beginning 'TRA4' are supplied in 304 stainless steel, part codes beginning TRA6 are supplied in 316 stainless steel.

## Water jacketed vessels

These stainless steel water jacketed vessels are available in 316L stainless steel, with a 304 stainless steel 0.1 bar low pressure water jacket. They are suitable for use with a non-pressurised water supply with hot or cold water for heating or cooling. These vessels are supplied with a 1/4" BSP water inlet at the bottom of the jacket and a 1/2" BSP outlet at the top. They have crevice- and pit-free interiors and are polished throughout.

| Item code | Capacity (ltr) | a (mm) | b (mm) |
|-----------|----------------|--------|--------|
| VEJ6002P  | 2              | 130    | 170    |
| VEJ6005P  | 5              | 175    | 230    |
| VEJ6006P  | 6              | 175    | 270    |
| VEJ6008P  | 8              | 200    | 270    |
| VEJ6010P  | 10             | 220    | 270    |
| VEJ6015P  | 15             | 267    | 275    |
| VEJ6020G  | 20             | 265    | 390    |
| VEJ6025G  | 25             | 300    | 390    |
| VEJ6030G  | 30             | 300    | 445    |
| VEJ6050G  | 50             | 350    | 535    |

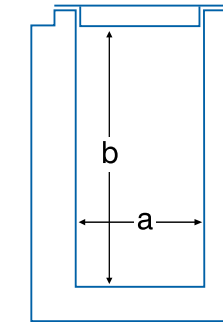

## Trays

### Shallow trays

Manufactured from 304 grade stainless steel, with several sizes available in 316L grade, these trays are supplied in one piece, with radiused corners. They are crevice- and pit-free, polished throughout, and have a rim approximately 10 mm wide.

| Item code | Length (mm) | Width (mm) | Depth (mm) | Weight (gm) |
|-----------|-------------|------------|------------|-------------|
| TRA4157S  | 157         | 162        | 10         | 165         |
| TRA4180S  | 180         | 120        | 10         | 177         |
| TRA4215S  | 215         | 160        | 10         | 214         |
| TRA4230S  | 230         | 162        | 10         | 240         |
| TRA4300S  | 300         | 200        | 10         | 404         |
| TRA4324S  | 325         | 317        | 10         | 665         |
| TRA4325S  | 325         | 265        | 10         | 550         |
| TRA4326S  | 325         | 143        | 10         | 300         |
| TRA4327S  | 325         | 234        | 10         | 495         |
| TRA4360S  | 360         | 240        | 10         | 629         |
| TRA4385S  | 385         | 210        | 10         | 706         |
| TRA4400S  | 400         | 270        | 10         | 706         |
| TRA4440S  | 440         | 325        | 10         | 1015        |
| TRA4451S  | 445         | 350        | 10         | 1059        |
| TRA4900S  | 490         | 320        | 19         | 1161        |
| TRA4495S  | 495         | 325        | 10         | 1000        |
| TRA4500S  | 500         | 162        | 10         | 530         |
| TRA4530S  | 530         | 325        | 10         | 1150        |
| TRA6290S  | 290         | 210        | 10         | 425         |
| TRA6320S  | 320         | 275        | 10         | 700         |
| TRA6415S  | 415         | 240        | 10         | 690         |



### Deep trays

Manufactured from 304 grade stainless steel, with several sizes available in 316L grade, these trays are supplied in one piece, with radiused corners. They are crevice- and pit-free and polished throughout.

| Item code | Length (mm) | Width (mm) | Depth (mm) | Weight (gm) |
|-----------|-------------|------------|------------|-------------|
| TRA4220D  | 220         | 150        | 45         | 310         |
| TRA4395D  | 395         | 280        | 70         | 1000        |
| TRA4450D  | 445         | 350        | 25         | 1135        |
| TRA4530D  | 530         | 325        | 100        | 2050        |
| TRA4531D  | 530         | 325        | 150        | 2375        |

**Note:** part codes beginning 'TRA4' are supplied in 304 stainless steel, part codes beginning TRA6 are supplied in 316 stainless steel.



## Pressure vessels

Pharma Hygiene Products manufacture pressure vessels suitable for lab scale/small batch production environments.

The types of pressure vessel we offer are:

- Vessel with internal pressure
- Vessel with internal vacuum pressure
- Pressurised heating or cooling jacket, with liquid in the jacket, with no pressure in the vessel
- Pressurised vessel with pressurised liquid heating jacket

Please note that to fall within the necessary Sound Engineering Practice specifications, Volume multiplied by Pressure must be equal to or less than 50.

## Polypropylene vessels

Pharma Hygiene Products can supply a range of mobile polypropylene vessels for products that cannot come into contact with stainless steel.

These vessels have welded seams and are supplied with drop on lids. An external stainless steel band can be added with two carrying handles to aid moving when empty. A mobile frame set on four castors (two braked) is an optional extra.

Propeller or high shear mixers can also be supplied, and the vessels are available in various sizes.

Please enquire for further information.



## Mobile mixers

Manufactured from 304 grade stainless steel, with 316L grade contact parts, these mixers are designed for use with any open vessel of suitable dimensions.

Available with either a high-shear mixing head for mixing emulsions, or a propeller mixing head for mixing free dissolving powders and for general mixing.

The mixing head is mounted on a mobile stand with painted hydraulic cylinder (manually operated), and the control panel is IP55 rated and constructed from stainless steel. Mixers can be specified with 3-phase or single phase power options.

Safety interlocks and a motor shroud are further options.

| Item code | Model                   | Operating rpm |
|-----------|-------------------------|---------------|
| CSP-HM    | Mobile high-shear mixer | 2900          |
| CSP-PM    | Mobile propeller mixer  | 1400          |



## Integrated mixers and agitators

Pharma Hygiene Products can supply a wide variety of mixers and agitators, and mount them on our standard and custom vessels and containers to meet your specific requirements.

We offer high-shear mixers for mixing emulsions, propeller mixers for free dissolving powders, as well as general mixing, and slow agitators for keeping products suspended. All can be supplied in varying power and speed specifications.

Please enquire for further information.



High shear mixer



Propeller mixer

Pharma Hygiene Products offer a range of stainless steel measuring and pouring equipment. Quality of material and construction is what sets us apart from our competitors.



## Measuring jugs

### Heavy duty measuring jugs (A)

Manufactured from 304 and 316L grade stainless steel, these jugs are straight sided, graduated and come with a pouring spout and closed side handle. They have crevice- and pit-free interiors and are polished throughout.

| Item code | Capacity (litres) | a   | b   | Handle | Graduation  | Weight (gm) |
|-----------|-------------------|-----|-----|--------|-------------|-------------|
| JUM*0.5G  | 0.5               | 75  | 135 | SIDE   | 0.1-0.5/0.1 | 285         |
| JUM*001G  | 1                 | 100 | 135 | SIDE   | 0.2-1/0.2   | 475         |
| JUM*002G  | 2                 | 135 | 170 | SIDE   | 0.2-2/0.2   | 690         |

**Note:** In the item code above replace the \* with 4 if 304 grade is required, or with 6 if 316L grade is required.

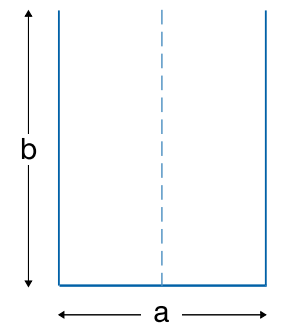

### Light duty measuring jugs (B)

Manufactured from 304 grade stainless steel, these jugs are tapered and come with either an open or closed handle. They are graduated in pints and litres, have crevice- and pit-free interiors and are polished throughout. The option of rimmed feet is available with the closed handle version from 0.5 litre upwards.

| Item code | Capacity (litres) | a   | b  | c   | Handle      | Graduation     | Weight (gm) |
|-----------|-------------------|-----|----|-----|-------------|----------------|-------------|
| MEA40.1G  | 0.1               | 75  | 40 | 45  | OPEN        | 0.05-0.1/0.05  | 40          |
| MEA4.25G  | 0.25              | 100 | 50 | 70  | OPEN        | 0.05-0.25/0.05 | 65          |
| ME*40.5G  | 0.5               | 120 | 60 | 110 | OPEN/CLOSED | 0.05-0.5/0.1   | 120         |
| ME*4001G  | 1                 | 150 | 75 | 135 | OPEN/CLOSED | 0.1-1/0.1      | 200         |
| ME*41.5G  | 1.5               | 155 | 85 | 150 | OPEN/CLOSED | 0.1-1.5/0.1    | 290         |
| ME*4002G  | 2                 | 170 | 85 | 200 | OPEN/CLOSED | 0.2-2/0.1      | 320         |

**Note:** In the item code above replace the \* with an A if an open handle is required, or with a C if a closed handle is required. For a rimmed foot, replace G with R.

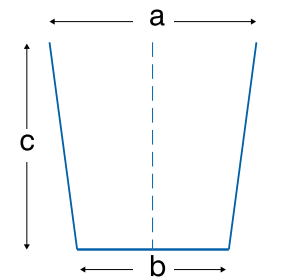



### Conical strainers

Manufactured from 304 grade stainless steel, these strainers are made from a one-piece body with a rolled top edge, and come complete with a long straight handle and a hanging hook. They are polished throughout.

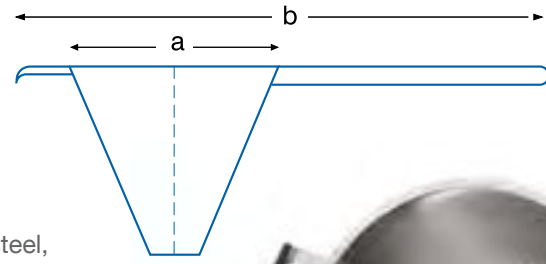

| Item code | a (mm) | b (mm) | Weight (gm) |
|-----------|--------|--------|-------------|
| STR4100P  | 65     | 100    | 80          |
| STR4120P  | 90     | 120    | 110         |
| STR4140P  | 110    | 140    | 135         |
| STR4160P  | 145    | 160    | 260         |
| STR4185P  | 170    | 185    | 290         |
| STR4200P  | 175    | 200    | 350         |
| STR4230P  | 210    | 230    | 430         |
| STR4270P  | 255    | 270    | 740         |

### Funnels with fixed strainers

Pharma Hygiene Products' funnels with roll tops and built-in fixed strainers are available in 304 grade stainless steel.

| Item code | a (mm) | b (mm) | c (mm) | d (mm) | Weight (gm) |
|-----------|--------|--------|--------|--------|-------------|
| FUN4109P  | 90     | 13.5   | 120    | 61     | 10          |
| FUN4112S  | 120    | 16     | 135    | 55     | 10          |
| FUN4116S  | 160    | 16     | 175    | 61     | 25          |
| FUN4120S  | 200    | 16     | 230    | 80     | 30          |
| FUN4125S  | 250    | 16     | 275    | 76     | 50          |

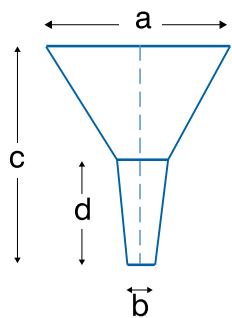

### Beakers

#### Light duty beakers (A)

Manufactured from 304 grade stainless steel, these beakers are made in one piece. They are crevice- and pit-free and polished throughout.

#### Heavy duty beakers (B)

Manufactured from 304 grade stainless steel, these beakers are made in one piece with a rolled over lip. They are crevice- and pit-free and polished throughout.



| Item code | Capacity (ml) | Diameter (mm) | Depth (mm) | Weight (gm) |
|-----------|---------------|---------------|------------|-------------|
| BEA4015C  | 150           | 60            | 60         | 110         |
| BEA4025C  | 250           | 85            | 50         | 115         |
| BEA4030C  | 300           | 100           | 50         | 200         |
| BEA4040C  | 400           | 85            | 85         | 210         |
| BEA4070C  | 700           | 100           | 100        | 325         |
| BEA4100C  | 1000          | 100           | 150        | 335         |
| BEA4125C  | 1250          | 120           | 120        | 445         |
| BEA4250C  | 2500          | 150           | 150        | 655         |
| BEA4600C  | 6000          | 200           | 200        | 1310        |

| Item code | Capacity (ml) | Diameter (mm) | Depth (mm) | Weight (gm) |
|-----------|---------------|---------------|------------|-------------|
| BEA4020P  | 200           | 60            | 75         | 105         |
| BEA4035P  | 350           | 65            | 115        | 170         |
| BEA4070P  | 700           | 75            | 165        | 290         |
| BEA4100P  | 1000          | 110           | 125        | 300         |
| BEA4125P  | 1250          | 100           | 165        | 360         |
| BEA4200P  | 2000          | 125           | 180        | 500         |
| BEA4250P  | 2500          | 150           | 160        | 600         |
| BEA4500P  | 5000          | 185           | 220        | 1025        |

Pharma Hygiene Products offer a range of stainless steel utensils which are widely used in the pharmaceutical, healthcare, cosmetics and food and beverage industries.

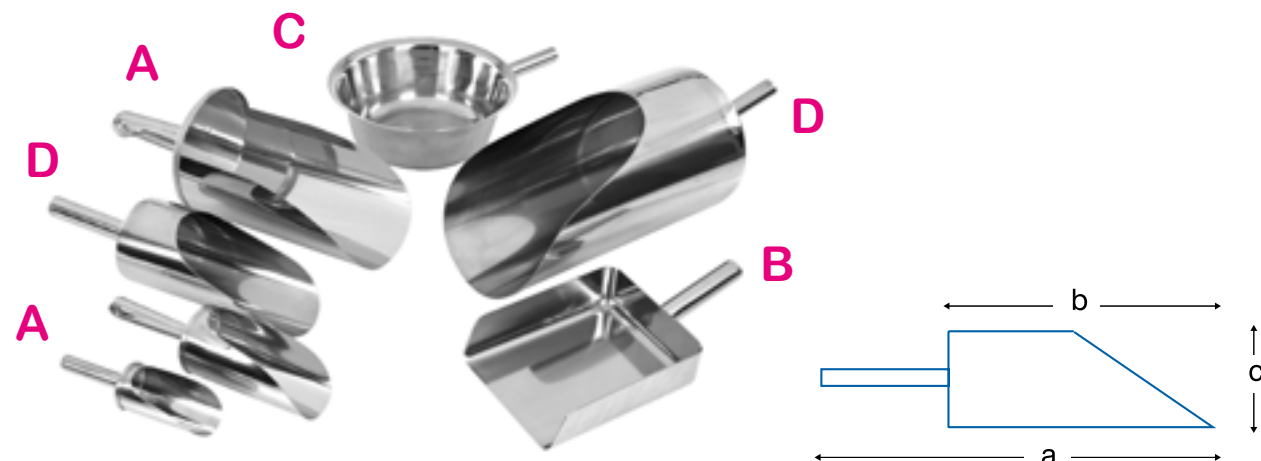

## Scoops

### Light duty scoops (A)

Manufactured from 304 grade stainless steel.

| Item code | Capacity (litres) | a   | b   | c   | Handle | Weight (gm) |
|-----------|-------------------|-----|-----|-----|--------|-------------|
| SCO4.15P  | 0.15              | 180 | 100 | 50  | ROUND  | 100         |
| SCO40.5P  | 0.5               | 260 | 150 | 75  | BAND   | 195         |
| SCO41.2P  | 1.2               | 330 | 195 | 100 | BAND   | 310         |
| SCO4200P  | 2                 | 380 | 230 | 120 | BAND   | 470         |
| SCO4300P  | 3                 | 400 | 250 | 160 | BAND   | 625         |

### Baler scoop (C)

Manufactured from 316L grade stainless steel, this scoop is crevice- and pit-free and polished throughout.

| Item code | Capacity (litres) | a   | b   | c  | Handle | Weight (gm) |
|-----------|-------------------|-----|-----|----|--------|-------------|
| BSC6000P  | 2                 | 345 | 245 | 90 | ROUND  | 930         |

### Heavy duty scoops (D)

Manufactured from 316L grade stainless steel, these scoops are crevice- and pit-free and polished throughout.

| Item code | Capacity (litres) | a   | b   | c   | Handle | Weight (gm) |
|-----------|-------------------|-----|-----|-----|--------|-------------|
| CFS600.5P | 0.5               | 288 | 168 | 60  | ROUND  | 290         |
| CFS6001P  | 1                 | 340 | 220 | 100 | ROUND  | 465         |
| CFS6002P  | 1.5               | 360 | 235 | 115 | ROUND  | 585         |
| CFS6200P  | 2                 | 385 | 260 | 130 | ROUND  | 785         |
| CFS6004P  | 4                 | 450 | 330 | 150 | ROUND  | 1300        |

## Ladles

Manufactured from 304 grade stainless steel, these ladles are crevice- and pit-free and polished throughout.

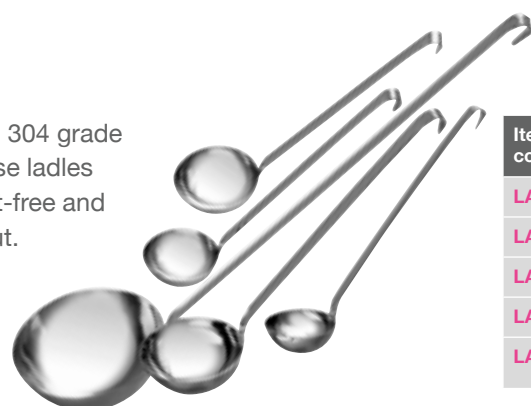

| Item code | Capacity (litres) | Handle length (mm) | Weight (gm) |
|-----------|-------------------|--------------------|-------------|
| LAD4120P  | 120               | 280                | 125         |
| LAD4150P  | 150               | 285                | 150         |
| LAD4200P  | 200               | 285                | 160         |
| LAD4300P  | 300               | 345                | 210         |
| LAD4340P  | 340               | 350                | 250         |

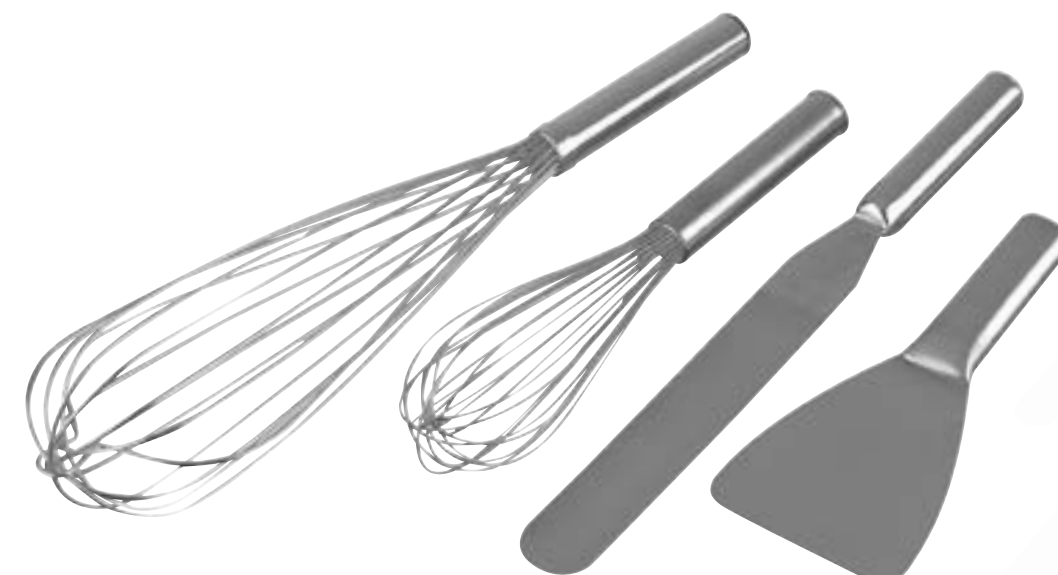

## Whisks, spatulas and scrapers

### Heavy duty whisks (A)

Manufactured from 304 grade stainless steel.

| Item code | Length (mm) | Weight (gm) |
|-----------|-------------|-------------|
| WHI4300HD | 300         | 250         |
| WHI4350HD | 350         | 300         |

### Medium duty whisks (B)

Manufactured from 304 grade stainless steel.

| Item code | Length (mm) | Weight (gm) |
|-----------|-------------|-------------|
| WHI4300P  | 300         | 140         |
| WHI4350P  | 350         | 145         |
| WHI4400P  | 400         | 150         |

### Spatulas (C)

These stainless steel spatulas are crevice- and pit-free and polished throughout.

| Item code | Length (mm) | Weight (gm) |
|-----------|-------------|-------------|
| SSP4004P  | 100         | 50          |
| SSP4006P  | 150         | 65          |
| SSP4008P  | 200         | 100         |
| SSP4010P  | 250         | 150         |
| SSP4012P  | 300         | 150         |

### Scraper (D)

Manufactured from 316L grade stainless steel, this scraper is crevice- and pit-free and polished throughout.

| Item code | Length (mm) | Weight (gm) |
|-----------|-------------|-------------|
| SCR6000P  | 230         | 200         |

## Paddle Stirrer

Manufactured from 316L grade stainless steel.

| Item code    | a (mm) | b (mm) | c (mm) | Weight (gm) |
|--------------|--------|--------|--------|-------------|
| PAD6200      | 1000   | 125    | 260    | 1200        |
| PAD6200-1300 | 1300   | 125    | 260    | 1500        |





Pharma Hygiene Products offer a range of stainless steel equipment for both private and NHS hospitals in the healthcare sector.

### Instrument boxes

Manufactured from 304 grade stainless steel, these instrument boxes come complete with a lid and are polished throughout. Perforated inserts are available in some sizes.



Part number INS4225P has rounded corners rather than the usual square corners.

| Box code | Length (mm) | Width (mm) | Depth (mm) | Weight (gm) | Insert code | Insert weight (gm) |
|----------|-------------|------------|------------|-------------|-------------|--------------------|
| INS4160P | 160         | 100        | 30         | 300         | N/A         | N/A                |
| INS4180P | 180         | 120        | 50         | 490         | N/A         | N/A                |
| INS4200P | 200         | 100        | 50         | 515         | INS4200PI   | 220                |
| INS4220P | 220         | 150        | 50         | 685         | N/A         | N/A                |
| INS4280P | 280         | 180        | 60         | 1095        | INS4280PI   | 440                |
| INS4420P | 420         | 80         | 50         | 805         | N/A         | N/A                |
| INS4500P | 500         | 200        | 80         | 2100        | N/A         | N/A                |
| INS4225P | 225         | 125        | 50         | 500         | N/A         | N/A                |



### Thermometer / tong jars

Manufactured from 304 grade, the body is constructed from one piece and soldered to the base. They have crevice- and pit-free interiors and are polished throughout.

| Item code | Height (mm) | Diameter (mm) | Base (mm) | Weight (gm) |
|-----------|-------------|---------------|-----------|-------------|
| JAR4090P  | 90          | 30            | 70        | 90          |
| JAR4130P  | 130         | 50            | 90        | 225         |
| JAR4180P  | 180         | 50            | 90        | 135         |
| JAR4200P  | 200         | 95            | 135       | 365         |

### Kidney dishes

Manufactured from 304 grade stainless steel, these kidney dishes are of one-piece construction. They are crevice- and pit-free and polished throughout.

| Item code | Length (mm) | Width (mm) | Depth (mm) | Weight |
|-----------|-------------|------------|------------|--------|
| KID4017P  | 170         | 100        | 40         | 130    |
| KID4020P  | 200         | 95         | 45         | 165    |
| KID4025P  | 250         | 135        | 45         | 200    |
| KID4027P  | 270         | 150        | 50         | 310    |



### Customised process equipment

Pharma Hygiene Products can meet your needs precisely. In addition to our extensive range of standard process equipment we can supply more sophisticated process equipment, engineered to meet your exact requirements, including:

- Jacketed vessels
- Mixing vessels
- Complete processing systems
- Pressure vessels

Adapting one of our standard products often provides a cost-effective solution, but we can also design and build vessels and other equipment to your specification. Please let us know if you have a project you wish to discuss and we will arrange a discussion with one of our engineers.



Pharma Hygiene Products' range of equipment enables users to work with tablets, capsules and fluids quickly, easily and accurately.

### Tablet and capsule counters

Pharma Hygiene Products supply a range of tablet and capsule counters to suit your needs.



#### Capsule counting tray

Manufactured from 304 grade stainless steel, this simple capsule counting tray has corrugations that allow 10 rows of 10 capsules up to 8 mm diameter to be counted quickly and easily. Only suitable for capsule sizes 0 to 5.

Size 175 x 88 mm. Sold in packs of 5.

#### Triangular tablet counter

Our range of manual triangular tablet counters are made from 304 stainless steel. They are designed for use with round tablets and allow the user to easily see the number of tablets in each batch. They can be supplied in two sizes - 7" or 10".

Sold in packs of 5.

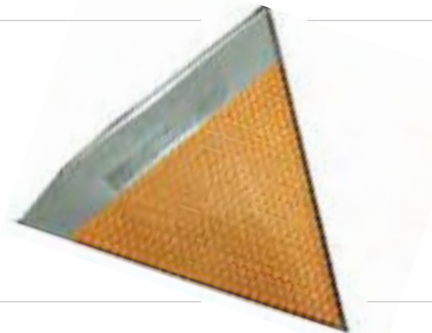

#### Tumatic capsule counter

Perspex construction for visual checking and easy cleaning.

Coated and uncoated tablets up to a diameter of 1/2" and capsules up to 3/4" long can be counted using a range of 5 interchangeable perforated plates. After filling the box, surplus tablets are poured back into the bulk container.

By partially withdrawing the slide, 5 to 10 tablets – depending on tray and tablet – are dropped into the bottom for easy dispensing into bottles. Full withdrawal dispenses 50 or 100 tablets.



#### Lifting-leaf tablet/capsule counter

These lifting-leaf counters are suitable for coated or uncoated tablets or capsules and, depending on diameter, can be made to count up to 100 units. Made from stainless steel, anodised aluminium and polycarbonate, these counters are made to order to match the samples provided by the customer.

The counter is used like a scoop and pushed into a pile of tablets or capsules. The requisite number of units falls into the holes and the excess is shaken off. The counter is then tilted back and used as a chute for filling bottles. \*Size and count depends on unit dimensions. Please enquire for more information.



| Item code | Specification                       |
|-----------|-------------------------------------|
| 6021100   | Capsule counting tray               |
| 6020607   | 7" triangular tablet counter        |
| 6020610   | 10" triangular tablet counter       |
| 6023100   | Tumatic capsule counter             |
| 6023301   | Lifting-leaf tablet counter, medium |
| 6023302   | Lifting-leaf tablet counter, large  |

### Capsule fillers

Pharma Hygiene Products supplies a range of high quality manual capsule fillers that are designed to enable the user to produce accurately filled capsules of a professional quality, in volumes of up to 9,000 per hour.



#### ProFiller capsule fillers

The ProFiller range of capsule fillers are capable of filling between 1,300 and 9,000 capsules per hour. They are easy to operate and are up to 35% faster than similar capsule fillers, due to their patented design.

Change parts and a full range of accessories, such as powder vibrators, are available for all models.

Please contact us for more detailed information and for the item numbers relating to each unit and set of change parts.

| Model          | Capacity (per cycle) | Max output (per hour) | Accuracy (USP/EP method) | Change parts sizes |
|----------------|----------------------|-----------------------|--------------------------|--------------------|
| PROFILLER 1100 | 100                  | 3400                  | ± 1-2%                   | 000-5, EL          |
| PROFILLER 1120 | 120                  | 3600                  | ± 1-2%                   | 00-4               |
| PROFILLER 3600 | 300                  | 6900                  | ± 1-3%                   | 000-4, EL          |
| PROFILLER 3700 | 300                  | 9000                  | ± 1-3%                   | 000-5, EL, AAA-D   |
| PROFILLER 3800 | 300                  | 9000                  | ± 1-3%                   | 00-4               |



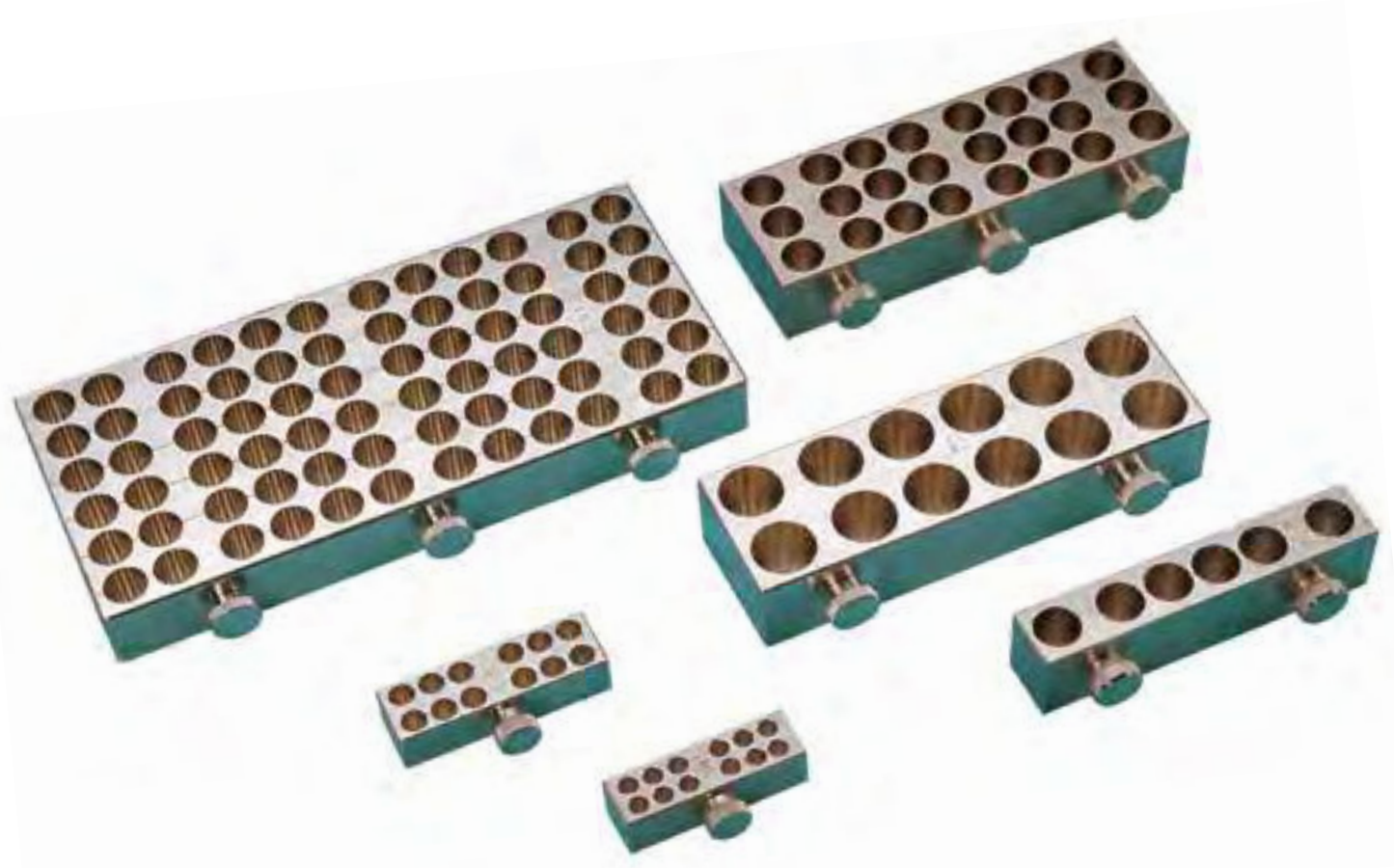

## Suppository and pessary moulds

Hand made for over fifty years, these moulds are manufactured from brass that is double nickel plated, and are accurate to within 10% if a Witepsol base is used. Standard moulds are conical in shape and range from 0.25g to 8gm. Torpedo shaped moulds are available to order for sizes 1g to 4g only.

| Conical mould<br>Item code | Torpedo mould<br>item code | Cavities | Size<br>(gm) |
|----------------------------|----------------------------|----------|--------------|
| 6005000                    | N/A                        | 6        | 0.25         |
| 6005001                    | N/A                        | 6        | 0.50         |
| 6005002                    | 6006002                    | 6        | 1.00         |
| 6005003                    | 6006003                    | 6        | 2.00         |
| 6005004                    | 6006004                    | 6        | 4.00         |
| 6005005                    | N/A                        | 6        | 8.00         |
| 6005100                    | N/A                        | 12       | 0.25         |
| 6005101                    | N/A                        | 12       | 0.50         |
| 6005102                    | 6006102                    | 12       | 1.00         |
| 6005103                    | 6006103                    | 12       | 2.00         |
| 6005104                    | 6006104                    | 12       | 4.00         |
| 6005105                    | N/A                        | 12       | 8.00         |
| 6005200                    | N/A                        | 24       | 0.25         |
| 6005201                    | N/A                        | 24       | 0.50         |
| 6005202                    | 6006202                    | 24       | 1.00         |
| 6005203                    | 6006203                    | 24       | 2.00         |
| 6005204                    | 6006204                    | 24       | 4.00         |
| 6005402                    | N/A                        | 40       | 1.00         |
| 6005403                    | N/A                        | 40       | 2.00         |
| 6005404                    | N/A                        | 40       | 4.00         |
| 6005602                    | N/A                        | 70       | 1.00         |
| 6005500                    | N/A                        | 100      | 0.25         |

## Optional modifications for storage, mixing and transport containers (see pages 1–5)

Your key to our range of optional fitted modifications for product ranges in the preceding pages, where red symbols identify the modifications available. If you require modifications that are not listed below, please contact us to discuss them. Please note that separate Butterfly Valves and Ball Valves, supplied unfitted, can be found on pages 22–23.



T

### Toggle clamps.

Available to secure lids. When used with O-ring seals can provide a spill proof and airtight seal.



▶10

### Graduations.

Can be added to items not graduated as standard. Stamped from the outside to maintain crevice- and pit-free interior. (Note: these graduations are normally accurate to ±3%).



E

### Special etching.

Any combination of letters and numbers can be etched into the surface of any item to show serial number, contents, location, etc. Logos or other graphics can also be etched.



⚙️

### Mobile frames.

Ideal for moving vessels smoothly and safely without lifting and carrying. Supplied with four castors, two of which are braked. Available with straight or angled flanges.



✂️

### Butterfly valves (fitted).

316L grade. Available in a variety of sizes detailed on page 20.



⚙️

### Ball valves (fitted).

316L grade. Available in a variety of sizes, as detailed on page 20.



⚙️

### Taps (fitted).

316L grade. Available in a variety of sizes, as detailed on page 20.



⚙️

### Bibs (fitted).

316L grade. Available to add to ball valves, in a variety of sizes, as detailed on page 20.



**Hose connectors (fitted).**

316L grade. Available to add to ball valves, in a variety of sizes, as detailed on page 20.

**Pouring spout.**

To aid pouring, spouts can be added to our standard vessels and cans. If a lid is required, this can be extended to cover the spout. With the addition of a pouring spout, a bottom steadying handle is recommended.

**Handles.**

Swing and side handles can be added or removed from standard items to suit.

**O-ring seals.**

Can be used in conjunction with our toggle clamps to create an airtight seal to our vessels, cans and pails. All seals are FDA approved and available in Nitrile, Viton® and Silicone.

**Hole in lid.**

To provide access for tubes, probes, mixer shafts etc. A 25mm hole with swing-side cover is available as standard. Other sizes available on request.

**Skirt band removal.**

The skirt band can be removed from items that usually have one, to ensure contact between the base of the container and a hot-plate, for example.

## Fitted valves, taps, bibs and hose connectors

We can fit a variety of outlets to our containers in a range of sizes. Please refer to the table below for part references. All contact parts are made from 316L grade stainless steel. Other sizes and types of outlet are available on request.

| Size            | 0.25"    | 0.375"   | 0.5"      | 0.75"      | 1"       | 1.5"     | 2"       | 2.5"     | 3"       | 4"       |
|-----------------|----------|----------|-----------|------------|----------|----------|----------|----------|----------|----------|
| Butterfly Valve | -        | -        | -         | -          | BVA6001P | BVA61.5P | BVA6002P | BVA62.5P | BVA6003P | BVA6004P |
| Ball Valve      | -        | -        | BVA600.5P | BVA600.75P | -        | -        | -        | -        | -        | -        |
| Tap unit        | TAP6.25P | TAP6.38P | TAP6.50P  | TAP6.75P   | TAP6001P | TAP61.5P | TAP6002P | -        | -        | -        |
| Bib             | BIB6.25P | BIB6.38P | BIB6.50P  | BIB6.75P   | BIB6001P | BIB61.5P | BIB6002P | -        | -        | -        |
| Hose Connector  | HTC6.25P | HTC6.38P | HTC6.50P  | HTC6.75P   | HTC6001P | HTC61.5P | HTC6002P | -        | -        | -        |

**Notes:**

- For pharmaceutical applications the fitting of a ball valve or butterfly valve is recommended. These hygienic outlets include Tri-Clamp fittings for easy removal and cleaning.
- Butterfly valves and ball valves include the valve, clamp, ferrule welded to the container, and seal (PTFE as standard on the Ball Valve, EPDM as standard on the Butterfly Valve). Alternative seals are available on request.
- With tap units, 'Size' refers to the BSP size. With Ball and Butterfly Valves, 'Size' refers to the pipe size.
- For valves supplied individually (unfitted), please refer to pages 22–23.

## Seals

Our seals are designed to work in conjunction with our toggle clamps to create a spillproof and airtight seal to our containers, lidded cans and pails. We offer the listed O-ring seals as standard. Other profiles and materials are available to special order. All seals are FDA approved.

|                              | Nitrile (NBR)  | Viton®  | Silicone   |
|------------------------------|--|---|--|
| Colour                       | Black  | Black   | White or red   |
| Temperature range            | -40°C to +110°C  | -25°C to +204°C   | -55°C to +204°C  |
| Recommended product uses     | Greases & oils<br>Water<br>Fuels<br>Alcohols<br>Ethylene glycol fluids   | Vacuum<br>Most acids and chemicals<br>Lube oils and greases   | Dry heat<br>Odourless and non-toxic products   |
| Not recommended for          | Ketones<br>Halogenated hydrocarbons<br>Brake fluids<br>Acetone   | Ketones<br>Brake fluids   | Ketones<br>Acids<br>Brake fluids   |
| Common industry applications | Oil and gas<br>Automotive fuels and oils   | Chemical processing<br>Automotive fuels and oils  | Pharma and life science projects<br>Food and beverage applications   |
| Mechanical Properties        | Good wear resistance<br>Good compression set resistance<br>Good permeation resistance<br>Good chemical and acid resistance | Good wear resistance<br>Excellent compression set resistance<br>Excellent permeation resistance<br>Excellent resistance to weathering | Poor wear resistance<br>Good compression set resistance<br>Good permeation resistance<br>Excellent permeation resistance |

**Note:** To order seals please specify the seal type, container type and container capacity in litres. For 'Mixing and storage containers' use V. For 'Cans with lids' use C. For 'Pails' use P. For example:

**Nitrile V50** = Nitrile seal for 50 litre container.

**Silicone C6** = Silicone seal for 6 litre can with lid.

**Viton P10** = Viton® seal for 10 litre pail.

## 304 or 316L stainless steel

Stainless steel is a durable, versatile and hygienic material that is resistant to corrosion and looks good.

There are over 200 different types of stainless steel, each with a different range of properties. However, five types account for the bulk of usage, and Pharma Hygiene Products supply product ranges in two types, known as 304 and 316L grade.

304 is an excellent general grade of stainless steel, suited to a range of uses. 316L is, however, recommended for pharmaceutical, cosmetic, food and dairy applications, as it has an even better corrosion resistance than 304 grade. All 316L grade items supplied by Pharma Hygiene Products are tested in-house using an X-ray analyser (see image), which confirms the grade of stainless steel, providing reassurance of the highest quality. Certificates confirming the grade and composition of stainless steel can be supplied on request at an additional cost.

Stainless steel has outstanding resistance to corrosion and attack from a wide range of chemical-based products. It is also more environmentally friendly than plastic disposable equipment, which has been favoured by the industry in recent times. In the face of growing pressure to integrate more sustainable, durable equipment into their processes, manufacturers are looking to stainless steel for a longer lasting solution.

X-ray analyser





## TRI-CLAMP FITTINGS

Easy to assemble and breakdown, Tri-Clamp fittings are ideal for applications requiring an easy method of cleaning to maintain optimum levels of hygiene. Their smooth crevice- and pit-free interiors offer non-contaminating, superior corrosion resistance and long service life.

Pharma Hygiene Products' Tri-Clamp fittings comprise a series of pipes and unisex joints, which are available welded or as separate elements. A gasket is sandwiched between joints and the union is completed with a clamp to create a leak-tight seal.

Our range includes 316L grade stainless steel fittings with outside pipe diameters from ½ inch to 4 inches. Gaskets are available in Silicone, Viton® and EPDM, and full material certification is available on all PHP Tri-Clamp fittings.

**Please note** that the Tri-Clamp items shown here on pages 22–26 are supplied as individual components. For ball valves or butterfly valves fitted to our range of containers, please see pages 19–20, or contact us for further details.

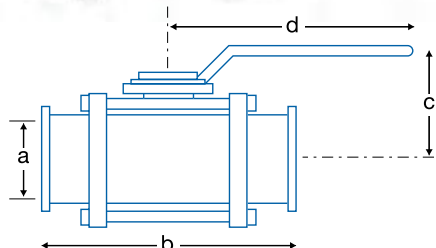

### Tri-Clamp ball valves

Manufactured from 316L grade stainless steel, with a PTFE seal/stem seal, PHP Tri-Clamp ball valves are 100% air tested under water at 100 psi in open and closed positions.

| Item code | Nominal pipe size (in) | Flange (mm) | a (mm) | b (mm) | c (mm) | d (mm) |
|-----------|------------------------|-------------|--------|--------|--------|--------|
| BAL60.5   | 0.5                    | 25          | 9.5    | 132    | 55     | 132    |
| BAL60.75  | 0.75                   | 25          | 15.9   | 144    | 60     | 131.5  |
| BAL61     | 1                      | 50.5        | 22.2   | 157    | 69     | 165    |
| BAL61.5   | 1.5                    | 50.5        | 35     | 183    | 84     | 194.3  |
| BAL62     | 2                      | 64          | 47.6   | 199    | 92     | 194.3  |
| BAL62.5   | 2.5                    | 77.5        | 60.3   | 240    | 126.8  | 252    |
| BAL63     | 3                      | 91          | 73     | 272    | 136    | 252    |
| BAL64     | 4                      | 119         | 97.4   | 285.7  | 242.7  | 333    |



### Tri-Clamp blank caps

Manufactured from 316L grade stainless steel and to BS4825, PHP Tri-Clamp blank caps are designed to blank off Ferrule Ends, when used with our Tri-Clamp gaskets and clamps. They are crevice- and pit-free and polished throughout.

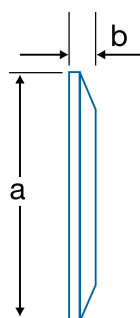

| Item code | Nominal pipe size (in) | a (mm) | b (mm) |
|-----------|------------------------|--------|--------|
| B21732012 | 0.5                    | 25     | 5.6    |
| B21732012 | 0.75                   | 25     | 5.6    |
| B21732100 | 1                      | 50.5   | 7      |
| B21732100 | 1.5                    | 50.5   | 7      |
| B21732200 | 2                      | 64     | 7      |
| B21732212 | 2.5                    | 77.5   | 7      |
| B21732300 | 3                      | 91     | 7      |
| B21732400 | 4                      | 119    | 9      |

## Tri-Clamp butterfly valves

Manufactured from 316L grade stainless steel, PHP Tri-Clamp plain butterfly valves include a 12-position lockable open or close handle and four bolts to dismantle for easy cleaning.

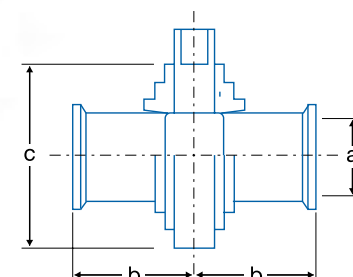
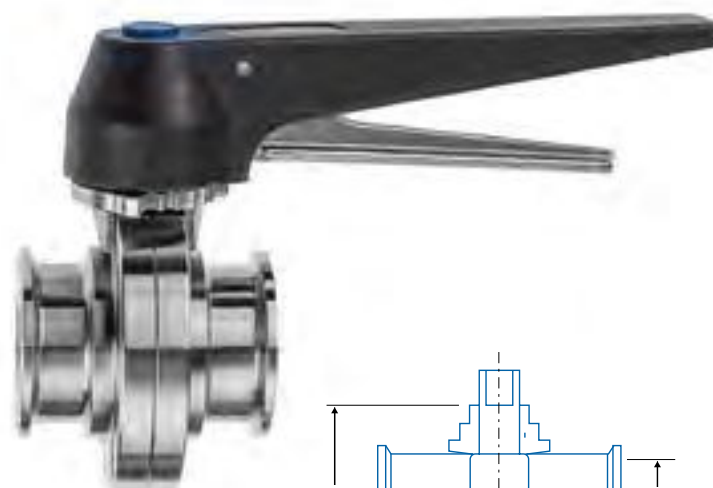

| Item code  | Nominal pipe size (in) | Flange (mm) | a (mm) | b (mm) | c (mm) |
|------------|------------------------|-------------|--------|--------|--------|
| BF42900100 | 1                      | 50.5        | 22.1   | 33     | 79     |
| BF42900112 | 1.5                    | 50.5        | 34.8   | 33     | 85     |
| BF42900200 | 2                      | 64          | 47.5   | 35     | 105    |
| BF42960212 | 2.5                    | 77.5        | 60.2   | 35     | 112    |
| BF42980300 | 3                      | 91          | 72.9   | 38     | 125    |
| BF42900400 | 4                      | 119         | 97.4   | 38     | 157    |

Valves supplied as standard with an EPDM seal. Also available with a silicone seal. Please add '-SS' to the end of the part number if a silicone seal is required.

## Tri-Clamp butterfly valve gasket seals

Manufactured from silicone, Viton® or EPDM, PHP butterfly valve gasket seals are designed for use with Tri-Clamp butterfly valves.



| Item code | Nominal pipe size (in) |
|-----------|------------------------|
| GVB*1     | 1                      |
| GVB*1.5   | 1.5                    |
| GVB*2     | 2                      |
| GVB*2.5   | 2.5                    |
| GVB*3     | 3                      |
| GVB*4     | 4                      |

**Note:** in this table, replace the "\*" with 'S' if silicone gasket is required, 'V' if Viton® is required or 'E' if EPDM is required.

## Tri-Clamp clamps

Manufactured from 316L grade stainless steel, these clamps are supplied with a double hinge for heavy duty use. They are designed to hold the ferrule ends firmly together to create a leak-tight seal.

As a general rule, we would advise that if the clamp, once in use, requires repeated tightening, this may indicate that the gasket should be replaced.



| Item code | Nominal clamp size (in) | Flange size (mm) |
|-----------|-------------------------|------------------|
| CL1703012 | 0.5                     | 25               |
| CL1703012 | 0.75                    | 25               |
| CL1703100 | 1                       | 50.5             |
| CL1703100 | 1.5                     | 50.5             |
| CL1703200 | 2                       | 64               |
| CL1703212 | 2.5                     | 64               |
| CL1703300 | 3                       | 91               |
| CL1703400 | 4                       | 119              |

## Tri-Clamp concentric reducers

Manufactured from 316L grade stainless steel, PHP concentric reducers provide the perfect solution to connecting existing Tri-Clamp connections to newer or changing ones. Available in a range of Tri-Clamp sizes, they have crevice- and pit-free interiors and are polished throughout.

| Item code    | Nominal size (in) | Item code   | Nominal size (in) | Item code | Nominal size (in) |
|--------------|-------------------|-------------|-------------------|-----------|-------------------|
| COR61-0.5    | 1 x 0.5           | COR62-1     | 2 x 1             | COR63-2   | 3 x 2             |
| COR61-0.75   | 1 x 0.75          | COR62-1.5   | 2 x 1.5           | COR63-2.5 | 3 x 2.5           |
| COR61.5-0.5  | 1.5 x 0.5         | COR62.5-1   | 2.5 x 1           | COR64-1   | 4 x 1             |
| COR61.5-0.75 | 1.5 x 0.75        | COR62.5-1.5 | 2.5 x 1.5         | COR64-1.5 | 4 x 1.5           |
| COR61.5-1    | 1.5 x 1           | COR62.5-2   | 2.5 x 2           | COR64-2   | 4 x 2             |
| COR62-0.5    | 2 x 0.5           | COR63-1     | 3 x 1             | COR64-2.5 | 4 x 2.5           |
| COR62-0.75   | 2 x 0.75          | COR63-1.5   | 3 x 1.5           | COR64-3   | 4 x 3             |

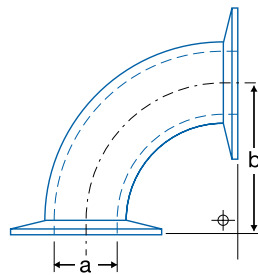

## Tri-Clamp elbows

Manufactured from 316L grade stainless steel. PHP 90° Tri-Clamp elbows come with ferrule ends, have crevice- and pit-free interiors and are polished throughout.

| Item code  | Nominal pipe size (in) | a (mm) | b (mm) |
|------------|------------------------|--------|--------|
| BN22117100 | 1                      | 22.1   | 50.8   |
| BN22117150 | 1.5                    | 34.8   | 69.9   |
| BN2117200  | 2                      | 47.5   | 88.9   |
| BN2117250  | 2.5                    | 60.2   | 108    |
| BN2117300  | 3                      | 72.9   | 127    |
| BN2117400  | 4                      | 97.38  | 168.2  |

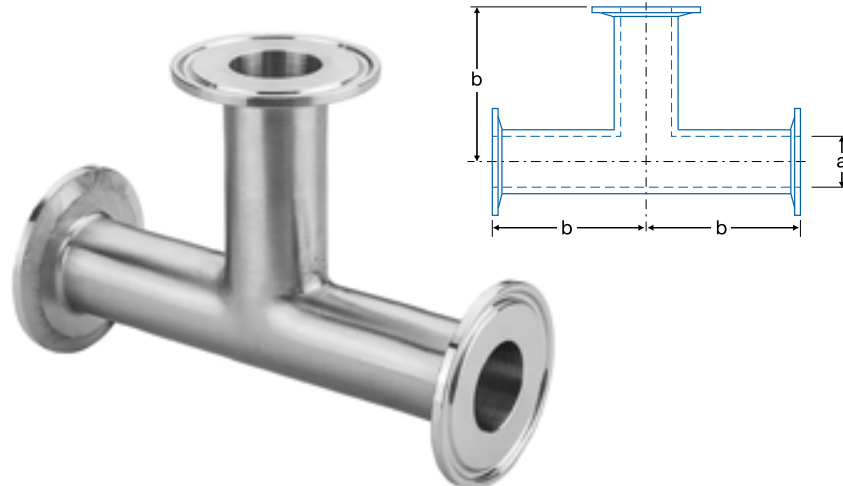

## Tri-Clamp equal tees

Manufactured from 316L grade stainless steel, PHP Tri-Clamp equal tees come with ferrule ends, have crevice- and pit-free interiors and are polished throughout.

| Item code | Nominal pipe size (in) | a (mm) | b (mm) |
|-----------|------------------------|--------|--------|
| TEE61     | 1                      | 25.4   | 60.3   |
| TEE61.5   | 1.5                    | 38.1   | 69.9   |
| TEE62     | 2                      | 50.8   | 88.9   |
| TEE62.5   | 2.5                    | 63.5   | 88.9   |
| TEE63     | 3                      | 76.1   | 95.3   |
| TEE64     | 4                      | 101.6  | 114.2  |

## Tri-Clamp ferrule ends

Manufactured from 316L grade stainless steel, PHP Tri-Clamp ferrule ends are supplied polished and ready for welding to our range of stainless steel pipes. Sizes supplied in 21.5mm, 28mm or 44.5mm lengths.

In the item codes, replace \* with 'S' for a 21.5mm length, 'M' for a 28mm length, and 'L' for a 44.5mm length.

| Item code  | Nominal pipe size (in) | a (in) | b (mm)         | c (mm) |
|------------|------------------------|--------|----------------|--------|
| TR*1722012 | 0.5                    | 9.5    | 21.5, 44.5     | 25     |
| TR*1722034 | 0.75                   | 15.85  | 21.5, 44.5     | 25     |
| TR*1722100 | 1                      | 22.2   | 21.5, 28, 44.5 | 50.5   |
| TR*1722112 | 1.5                    | 34.9   | 21.5, 28, 44.5 | 50.5   |
| TR*1722200 | 2                      | 47.6   | 21.5, 28       | 64     |
| TR*1722212 | 2.5                    | 60.3   | 21.5, 28       | 77.5   |
| TR*1712300 | 3                      | 73     | 21.5, 28       | 91     |
| TR*1722400 | 4                      | 97.6   | 21.5, 28       | 119    |

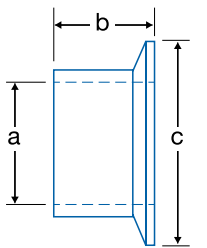

## Tri-Clamp ferrule end gaskets

Manufactured from silicone, PTFE, Viton and EPDM to BS4825, PHP Tri-Clamp ferrule end Gaskets are designed to form a seal between ferrule ends when used in conjunction with our Tri-Clamp clamps.

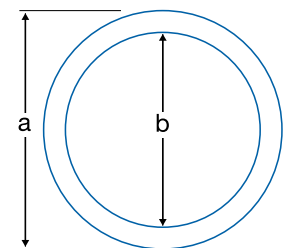

### Silicone, Viton® or EPDM gaskets

| Item code | Nominal pipe size (in) | a (mm) | b (mm) |
|-----------|------------------------|--------|--------|
| **1707012 | 0.5                    | 22     | 9.52   |
| **1707034 | 0.75                   | 22     | 15.87  |
| **1707100 | 1                      | 50.5   | 22.2   |
| **1707112 | 1.5                    | 50.5   | 34.9   |
| **1707200 | 2                      | 64     | 47.6   |
| **1707212 | 2.5                    | 77.5   | 60.3   |
| **1707300 | 3                      | 91     | 73     |
| **1707400 | 4                      | 119    | 97.6   |

In the item codes shown in the table to the left, replace \*\* with SS for silicone gaskets, VI for Viton® gaskets or ES for EPDM gaskets. If PTFE material is required, quote the item codes shown in the table to the right.

### PTFE gaskets

| Item code    | Nominal pipe size (in) | a (mm) | b (mm) |
|--------------|------------------------|--------|--------|
| PTFE6000.5P  | 0.5                    | 22     | 9.52   |
| PTFE6000.75P | 0.75                   | 22     | 15.87  |
| PTFE6001P    | 1                      | 50.5   | 22.2   |
| PTFE6001.5P  | 1.5                    | 50.5   | 34.9   |
| PTFE6002P    | 2                      | 64     | 47.6   |
| PTFE6002.5P  | 2.5                    | 77.5   | 60.3   |
| PTFE6003P    | 3                      | 91     | 73     |
| PTFE6004P    | 4                      | 119    | 97.6   |





### Tri-Clamp straight pipes

Manufactured from 316L grade stainless steel, PHP Tri-Clamp straight pipes have crevice- and pit-free interiors and are polished throughout.

| Item code    | Nominal pipe size (in) | a (in) | b (mm) |
|--------------|------------------------|--------|--------|
| STR60.5-***  | 0.5                    | 9.5    | 25     |
| STR60.75-*** | 0.75                   | 15.85  | 25     |
| STR61-***    | 1                      | 22.2   | 50.5   |
| STR61.5-***  | 1.5                    | 34.9   | 50.5   |
| STR62-***    | 2                      | 64     | 64     |
| STR62.5-***  | 2.5                    | 60.3   | 77.5   |
| STR63-***    | 3                      | 73     | 91     |
| STR64-***    | 4                      | 97.6   | 119    |

**Note:** In the item code replace \*\*\* with the required length of pipe.

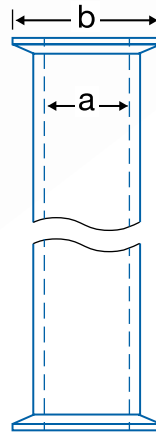

### Tri-Clamp hose tail connectors

Manufactured from 316L grade stainless steel, PHP Tri-Clamp hose tail pipes have crevice- and pit-free interiors and are polished throughout.

| Item code   | Nominal pipe size (in) | a (in) | b (mm) | c (mm) |
|-------------|------------------------|--------|--------|--------|
| HTC21772012 | 0.5                    | 12.7   | 32     | 25     |
| HTC21772034 | 0.75                   | 19     | 32     | 25     |
| HTC21772100 | 1                      | 26     | 40     | 50.5   |
| HTC21772150 | 1.5                    | 38.1   | 40     | 50.5   |
| HTC21772200 | 2                      | 50.8   | 60     | 60     |
| HTC21772250 | 2.5                    | 63.5   | 60     | 77.5   |
| HTC21772300 | 3                      | 76.2   | 60     | 91     |

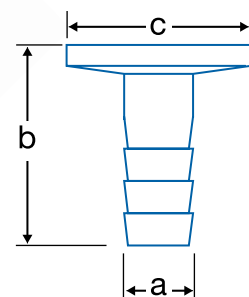

## INDUSTRIES WE SERVE

### Pharmaceutical and Healthcare

We have excellent knowledge of the strict regulations that pharmaceutical manufacturers must adhere to, and of GMP standards. Stainless steel mixing and storage containers can all be supplied in 316L pharmaceutical grade stainless steel. The use of an X-ray analyser enables us to provide full traceability on all material, along with the relevant certification.

### Cosmetics and Personal Care

Whether the products are exclusive to a luxury spa or hotel, or part of a high-volume range sold through multinational supermarkets, cosmetics and personal care product manufacturers can rely on us to supply the highest quality stainless steel process equipment.

### Food and Beverage

All of our stainless steel products are manufactured with food hygiene in mind. Most of our stainless steel containers are crevice- and pit-free to avoid bug traps. Our range of process equipment is ideal for food production environments where manufacturers require stainless steel of the highest quality. We also provide equipment for use in catering environments.

### Research and Laboratory

Our products are perfectly suited to use by researchers and laboratory technicians developing and producing liquid-based drugs. All our products conform to strict pharmaceutical regulations, and come with the necessary certification. Customers in this area cover the spectrum of life sciences and clinical diagnostics, striving to improve global healthcare, to create new life-saving treatments for hospitals, or to advance veterinary medicine.

### E-Liquid

Manufacturing and mixing processes in the production of E-liquids will benefit from the use of our high quality stainless steel mixing containers and utensils. These products are fully compliant with all new regulations applying to the mixing and blending of vaping oils with flavourings.

### PHARMA HYGIENE PRODUCTS

Olympus House • Mill Green Road • Haywards Heath • West Sussex RH16 1XQ • UK

+44 (0)1444 472300

info@pharmahygieneproducts.com

www.pharmahygieneproducts.com



902 304 316

quilinox@quilinox.com

www.quilinox.com



# The Adelphi Group of Companies

## Adelphi Manufacturing

Adelphi Manufacturing offers manual and semi-automatic equipment designed to aid the efficient opening, filling, closing and inspecting of a variety of containers such as capsules, ampoules, vials, syringes, tubes and bottles. It also offers a range of pharmaceutical dispensing equipment, and is the sole UK agent for TGM tube fillers and ROTA ampoule fillers.

[sales@adelphi.uk.com](mailto:sales@adelphi.uk.com)  
[www.adelphi-le.com](http://www.adelphi-le.com)

## Adelphi Healthcare Packaging

Suppliers of a comprehensive range of glass, plastic and aluminium containers, high precision dispensing systems, various closures including stoppers, crimp seals and screw caps as well as a range of boxes, held in stock ready for immediate dispatch worldwide.

[sales@adelphi-hp.com](mailto:sales@adelphi-hp.com)  
[www.adelphi-hp.com](http://www.adelphi-hp.com)

## Adelphi Masterfil

Manufacturers of filling and capping machinery, from single machines to complete turnkey lines. Adelphi Masterfil primarily serves the lube oil, chemical (including household and agrochemical), cosmetics and food industries.

[sales@masterfil.com](mailto:sales@masterfil.com)  
[www.masterfil.com](http://www.masterfil.com)

## Pharma Hygiene Products

Pharma Hygiene Products is a leading supplier of high quality stainless steel process equipment, from standard utensils and containers, to custom designed mixing vessels to suit a number of manufacturing industries. All are made to pharmaceutical standards in 304 and 316L grade stainless steel.

[info@pharmahygieneproducts.com](mailto:info@pharmahygieneproducts.com)  
[www.pharmahygieneproducts.com](http://www.pharmahygieneproducts.com)



**Adelphi  
Manufacturing**



**Adelphi Healthcare  
Packaging**



**Masterfil®**



**Pharma Hygiene  
Products**



**QUILINOX®**  
ALL ABOUT FLUIDS



902 304 316  
[quilinox@quilinox.com](mailto:quilinox@quilinox.com)  
[www.quilinox.com](http://www.quilinox.com)





# Pharma Hygiene Products

[www.pharmahygieneproducts.com](http://www.pharmahygieneproducts.com)



**QUILINOX**<sup>®</sup>  
ALL ABOUT FLUIDS



902 304 316  
[quilinox@quilinox.com](mailto:quilinox@quilinox.com)  
[www.quilinox.com](http://www.quilinox.com)

