

Valvole a farfalla Butterfly valves



ZVF

VVF

DATI TECNICI



STRUTTURA VALVOLA		
Conessioni da DN10 a DN150	DIN, SMS, IDF, BS (RJT), Clamp, Flangia	Altre connessioni a richiesta
Materiale a contatto con il prodotto	AISI 316L (1.4404)	Altro materiale a richiesta
Materiale guarnizioni a contatto con il prodotto (omologazione FDA)	EPDM, FKM, HNBR, MVQ	Altro materiale a richiesta
Temperatura massima prodotto (EPDM applicazioni con aria)	120 °C (248 °F)	Per temperature diverse contattare Bardiani Valvole
Temperatura minima prodotto (EPDM applicazioni con aria)	-10 °C (14 °F)	
Pressione massima prodotto	10 bar (145 psi)	
Finitura superficiale materiale a contatto con il prodotto	Ra 0.8 µm (altri tipi di finitura a richiesta)	
STRUTTURA ATTUATORE PNEUMATICO		
Attacchi aria	1/8" (BSP) per tubo 6x4mm	
Pressione	Da 6 bar (87 psi) a 8 bar (116 psi)	
Materiale cilindro	AISI 304 (1.4301)	
Materiale guarnizioni	NBR	
COMANDO MANUALE		
Materiale maniglia	Plastica (PA6 GF30)	AISI 304 (1.4301) su richiesta



TECHNICAL DETAILS

VALVE STRUCTURE		
Connections from DN10 to DN150	DIN, SMS, IDF, BS (RJT), Clamp, Flange	Other connections on request
Material in contact with the product	AISI 316L (1.4404)	Other material on request
Material gaskets in contact with the product (FDA homologation)	EPDM, FKM, HNBR	Other material on request
Max product temperature (EPDM applications with air)	120 °C (248 °F)	For other temperature, please ask Bardiani Valvole
Min product temperature (EPDM applications with air)	-10 °C (14 °F)	
Max. product pressure	10 bar (145 psi)	
Finish on surfaces in contact with the product	Ra 0.8 µm (other types of surface finish on request).	
PNEUMATIC ACTUATOR STRUCTURE		
Air connectors	1/8" (BSP) for pipe 6x4mm	
Air pressure	From 6 bar (87psi) to 8 bar (116psi)	
Cylinder material	AISI 304 (1.4301)	
Gasket material	NBR	
HAND CONTROL		
Handle material	Plastic (PA6 GF30)	AISI 304 (1.4301) on request

 CERTIFICAZIONI
CERTIFICATIONS

VVF- VALVOLA FARFALLA MANUALE

Disponibile nelle versioni in plastica oppure su richiesta in acciaio inox. Affidabile ed estremamente flessibile. La valvola manuale farfalla VVF sfrutta tutta la componentistica della valvola ZVF, tranne la parte pneumatica.

VVF- MANUAL BUTTERFLY VALVE

Available in plastic or stainless steel (upon request). Reliable and extremely flexible. the VVF manual valve uses all the parts from the ZVF valve apart from the pneumatic components.



ATTACCO WAFER4

Questa tipologia di attacco disponibili per la linea della valvole farfalla, è stata progettata con l'obiettivo di semplificare la rimozione della valvola dalla linea di tubazione durante le operazioni di manutenzione.

WAFER4 CONNECTION

This particular type of connection fitting enables to pull off easily the valve body from the piping, during maintenance operations.



Attacco WAFER4
WAFER4 connection

SENSORI PER VVF

L'applicazione di uno o due proximity sensors consente la segnalazione di posizione della valvola in fase di apertura e di chiusura.

VVF PROXIMITIES

The installation of 1 or 2 proximity sensors allows the signaling of valve position during open and close phases.



LIMITATORE DI CORSA

Accessorio che consente la regolazione meccanica dell'escursione della valvola.

STROKE LIMITER

Adjustable device which allows the mechanical limitation of valve stroke.

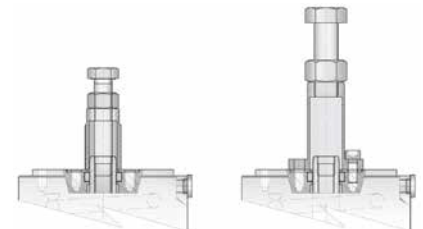

ESECUZIONI SPECIALI SU RICHIESTA

Ogni accessorio è disponibile su richiesta del cliente per tutti i diametri e tutte le configurazioni corpi valvola. È inoltre possibile la personalizzazione di attacchi, diametri oppure soluzioni non presenti a catalogo. Bardiani Valvole consiglia di consultare sempre l'ufficio tecnico in fase d'ordine per ulteriori informazioni e studi di fattibilità.

SPECIAL OPTIONS AND VARIATION ON REQUEST

On request all accessories are available for all sizes of valve and body configurations. Additionally special ports, diameters and other tailor-made solutions are available. Bardiani Valvole can also provide technical support, advice and feasibility analysis for other requests.

SALDARE

WELD

DIN

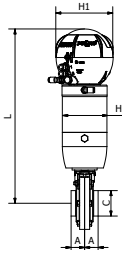

DN	A	B	C	D	E	E1	H	H1	L
10	30	97	12x1	62	160	150	90	112	323
15	30	97	18x1	62	160	150	90	112	323
20	32	106	22x1.5	80	160	150	90	112	331
25	32	107	28x1.5	80	160	150	90	112	331
32	34	109	34x1.5	85	160	150	90	112	333
40	35	112	40x1.5	92	160	150	90	112	337
50	40	118	52x1.5	104	160	150	90	112	343
65	43	129	70x2	125	160	150	105	112	356
80	36	137	85x2	142	160	150	105	112	364
100	36	147	104x2	162	160	150	105	112	374
125	56	161	129x2	200	-	219	168	145	491
150	62	176	154x2	230	-	219	168	145	504

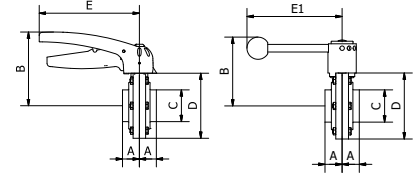

SALDARE

WELD

DIN 11850/2

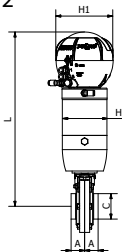

DN	A	B	C	D	E	E1	H	H1	L
10	30	97	13x1.5	62	160	150	90	112	323
15	30	97	19x1.5	62	160	150	90	112	323
20	32	106	23x1.5	80	160	150	90	112	331
25	32	107	29x1.5	80	160	150	90	112	331
32	34	109	35x1.5	85	160	150	90	112	333
40	35	112	41x1.5	92	160	150	90	112	337
50	40	118	53x1.5	104	160	150	90	112	343
65	43	129	70x2	125	160	150	105	112	356
80	36	137	85x2	142	160	150	105	112	364
100	36	147	104x2	162	160	150	105	112	374
125	56	161	129x2	200	-	219	168	145	491
150	62	176	154x2	230	-	219	168	145	504

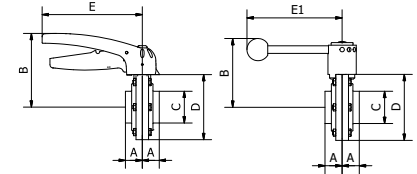

FEMMINA

MALE

DIN

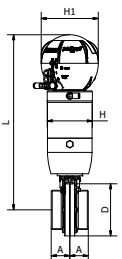

DN	A	B	D	E	E1	H	H1	L
10	34	97	62	160	150	90	112	323
15	34	97	62	160	150	90	112	323
20	35	106	80	160	150	90	112	331
25	35	107	80	160	150	90	112	331
32	36	109	85	160	150	90	112	333
40	35	112	92	160	150	90	112	337
50	37	118	104	160	150	90	112	343
65	41	129	125	160	150	105	112	356
80	46	137	142	160	150	105	112	364
100	47	147	162	160	150	105	112	374
125	56	161	200	-	219	168	145	491
150	62	176	230	-	219	168	145	504

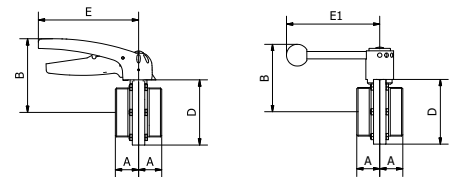

MASCHIO+GIRELLA

LINER+NUT

DIN

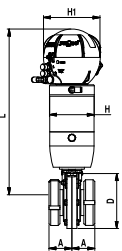

DN	A	B	D	E	E1	H	H1	L
10	-	-	-	-	-	-	-	-
15	35	97	62	160	150	90	112	323
20	38	106	80	160	150	90	112	331
25	38	107	80	160	150	90	112	331
32	41	109	85	160	150	90	112	333
40	41	112	92	160	150	90	112	337
50	46	118	104	160	150	90	112	343
65	50	129	125	160	150	105	112	356
80	57	137	142	160	150	105	112	364
100	70	147	162	160	150	105	112	374
125	90	161	200	-	219	168	145	491
150	99	176	230	-	219	168	145	504

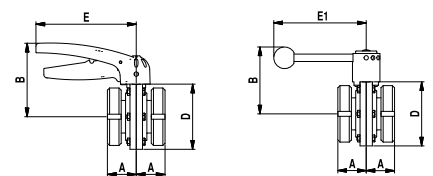

FEMMINA - SALDARE
MALE - WELD

DIN

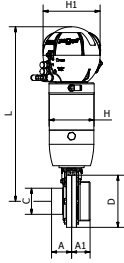

DN	A	A1	B	C	D	E	E1	H	H1	L
10	30	34	97	12x1	62	160	150	90	112	323
15	30	34	97	18x1	62	160	150	90	112	323
20	32	35	106	22x1.5	80	160	150	90	112	331
25	32	35	107	28x1.5	80	160	150	90	112	331
32	34	36	109	34x1.5	85	160	150	90	112	333
40	35	35	112	40x1.5	92	160	150	90	112	337
50	40	37	118	52x1.5	104	160	150	90	112	343
65	43	41	129	70x2	125	160	150	105	112	356
80	36	46	137	85x2	142	160	150	105	112	364
100	36	47	147	104x2	162	160	150	105	112	374
125	56	56	161	129x2	200	-	219	168	145	491
150	62	62	176	154x2	230	-	219	168	145	504

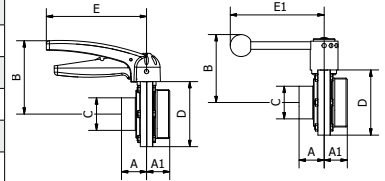

MASCHIO+GIRELLA -
FEMMINA
LINER+NUT - MALE

DIN

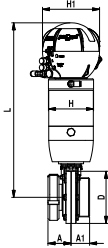

DN	A	A1	B	D	E	E1	H	H1	L
10	-	-	-	-	-	150	-	-	-
15	35	34	97	62	160	150	90	112	323
20	38	35	106	80	160	150	90	112	331
25	38	35	107	80	160	150	90	112	331
32	41	36	109	85	160	150	90	112	333
40	41	35	112	92	160	150	90	112	337
50	46	37	118	104	160	150	90	112	343
65	50	41	129	125	160	150	105	112	356
80	57	46	137	142	160	150	105	112	364
100	70	47	147	162	160	150	105	112	374
125	90	56	161	200	-	219	168	145	491
150	99	62	176	230	-	219	168	145	504

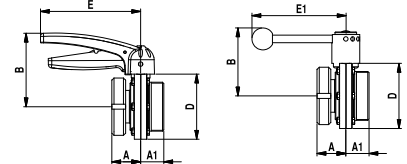

FEMMINA
MALE
IDF

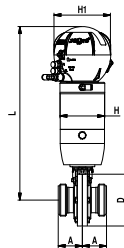

DN	A	B	D	E	E1	H	H1	L
1"	47.5	107	80	160	150	90	112	331
1 1/2"	46.5	109	92	160	150	90	112	337
2"	48.5	112	104	160	150	90	112	343
2 1/2"	49.5	126	120	160	150	105	112	355
3"	51.5	131	130	160	150	105	112	359
4"	57.5	147	162	160	150	105	112	374

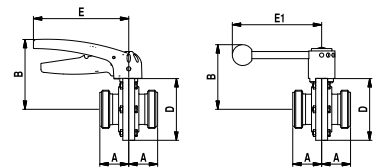

FEMMINA
MALE
BS (RJT)

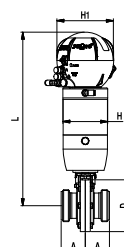

DN	A	B	D	E	E1	H	H1	L
1"	47.5	107	80	160	150	90	112	331
1 1/2"	46.5	109	92	160	150	90	112	337
2"	48.5	112	104	160	150	90	112	343
2 1/2"	49.5	126	120	160	150	105	112	355
3"	51.5	131	130	160	150	105	112	359
4"	57.5	147	162	160	150	105	112	374

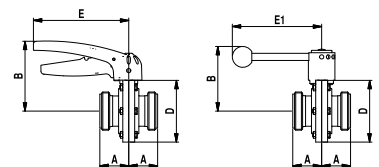

WAFER4

DIN

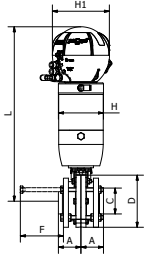

DN	A	B	C	D	E	E1	F	H	H1	L
15	45	97	19x1,5	62	160	150	90	90	112	323
20	45	107	23x1.5	80	160	150	90	90	112	331
25	45	107	29x1.5	80	160	150	90	90	112	331
32	45	109	35x1.5	85	160	150	90	90	112	333
40	45	112	41x1.5	92	160	150	90	90	112	337
50	45	118	53x1.5	104	160	150	90	90	112	343
65	45	129	70x2	125	160	150	90	105	112	356
80	49	137	85x2	142	160	150	100	105	112	364
100	52	147	104x2	162	160	150	105	105	112	374
125	61	161	129x2	200	-	219	115	168	145	491
150	71	176	154x2	230	-	219	130	168	145	504

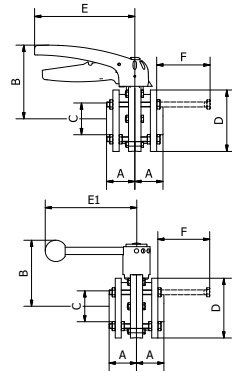

WAFER4

INCH

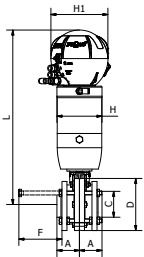

DN	A	B	C	D	E	E1	F	H	H1	L
3/4"	45	107	19.05x1.65	80	160	150	90	90	112	331
1"	45	107	25.4x1.65	80	160	150	90	90	112	331
1 1/2"	45	112	38.1x1.65	92	160	150	90	90	112	337
2"	45	118	50.8x1.65	104	160	150	90	90	112	343
2 1/2"	45	129	63.5x1.65	125	160	150	90	105	112	355
3"	49	137	76.2x1,65	142	160	150	105	105	112	359
4"	52	147	101.6x2,11	162	160	150	115	105	112	374
6"	71	176	152.4x2,77	230	-	219	130	168	145	504

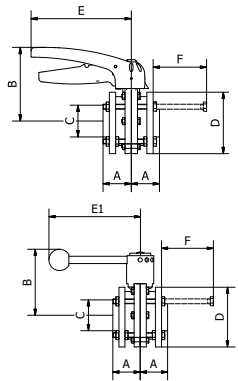

SALDARE

WELD

INCH

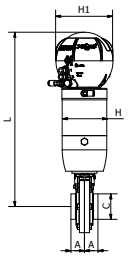

DN	A	B	C	D	E	E1	H	H1	L
1"	26	107	25.4x1.5	80	160	150	90	112	331
1 1/2"	25	109	38.1x1.5	92	160	150	90	112	337
2"	27	112	50.8x1.5	104	160	150	90	112	343
2 1/2"	28	126	63.5x1.5	120	160	150	105	112	355
3"	30	131	76.1x2	130	160	150	105	112	359
4"	36	147	101.6x2	162	160	150	105	112	374
5"	56	161	127x2	200	220	150	168	145	491
6"	62	176	152.4x2	230	-	219	168	145	504

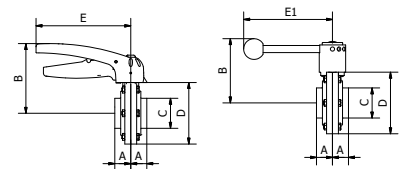

CLAMP

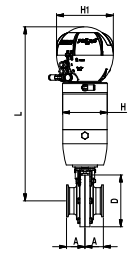

DN	A	B	D	E	E1	H	H1	L
1"	35	107	80	160	150	90	112	331
1 1/2"	35	109	92	160	150	90	112	337
2"	37	112	104	160	150	90	112	343
2 1/2"	41	126	120	160	150	105	112	356
3"	43	131	130	160	150	105	112	364
4"	51.5	147	162	160	150	105	112	374
6"	90.5	147	162	-	219	167	145	504

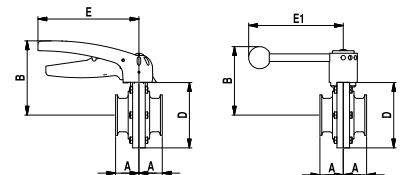

FEMMINA

MALE

SMS

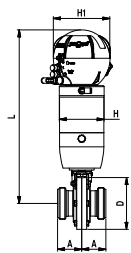

DN	A	B	D	E	E1	H	H1	L
1"	35	107	80	160	150	90	112	331
1 1/2"	37	109	92	160	150	90	112	337
2"	39	112	104	160	150	90	112	343
2 1/2"	52	126	120	160	150	105	112	356
3"	54	131	130	160	150	105	112	364
4"	61	147	162	160	150	105	112	374

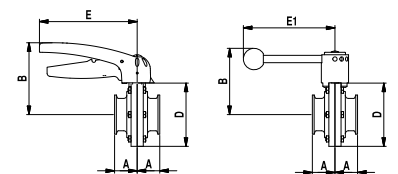

LEGENDA / KEY

-	Su richiesta / On demand
---	--------------------------

DIMENSIONI ATTUATORE PNEUMATICO MACH PER VALVOLA FARFALLA

PNEUMATIC MACH ACTUATOR DIMENSIONS FOR BUTTERFLY VALVE

MACH 83-98

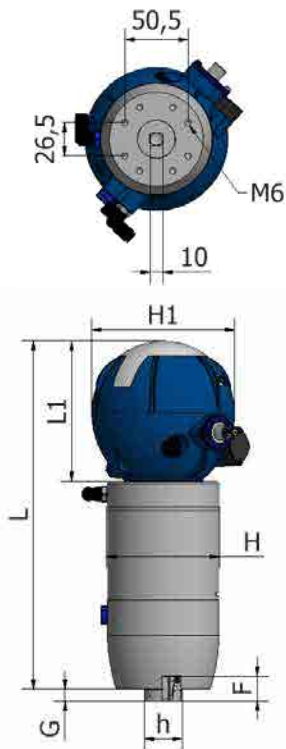

MACH 156

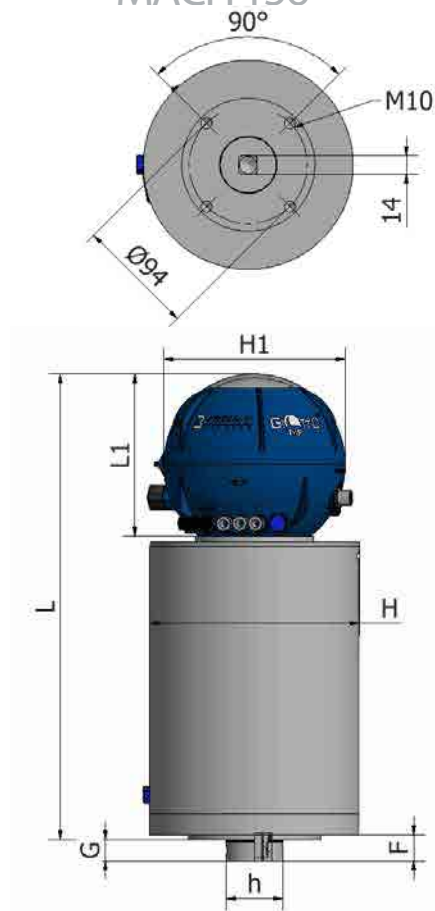

	F	G	H	H1	h	L	L1
83 SE - DE	20	10	90	112	30	275	109
98 SE - DE	20	10	105	112	30	275	109
156 SE - DE	20	16	168	145	45	370	128

LEGENDA / KEY	
SE	Semplice Effetto / Single acting
DE	Doppio Effetto / Double Acting
83 - 98 - 156	Diametro attuatore / Actuator diameter

RACCOMANDAZIONI

- 1 E' obbligatoria la consultazione del Manuale di Istruzioni, Uso e Manutenzione" prima di procedere all'installazione, all'utilizzo e alla manutenzione dei Prodotti. Tutte le informazioni, le indicazioni, le specifiche e le notizie tecniche qui riportate sono basate su dati di prove che Bardiani Valvole S.p.A. ritiene attendibili, ma che non sono riferibili ad ogni possibile utilizzo del Prodotto.
- 2 Le raffigurazioni e i disegni, tutti di valore generale, indicativo e non vincolante, possono non corrispondere alle reali condizioni dei Prodotti.
- 3 Dal momento che le condizioni di uso e applicazione del Prodotto ed il suo utilizzo sono al di fuori del controllo di Bardiani Valvole S.p.A., l'Acquirente deve preventivamente accertare la sua idoneità all'uso al quale intende destinarlo e assume ogni conseguente rischio e responsabilità che ne deriva dall'uso stesso.
- 4 Si raccomanda all'Acquirente di consultare sempre i collaboratori tecnici-commerciali di Bardiani Valvole S.p.A. per richiedere informazioni specifiche in merito alle caratteristiche tecniche dei Prodotti.
- 5 Quanto riportato nel presente Manuale si riferisce a prodotti di standard di Bardiani Valvole S.p.A. e non può in nessun caso costituire un riferimento di base per prodotti realizzati su specifiche richieste.
- 6 Bardiani Valvole S.p.A. si riserva il diritto, senza obbligo alcuno di comunicazione, di modificare e/o integrare e/o aggiornare, in qualsiasi momento, i dati e/o le informazioni e/o le notizie tecniche relative ai Prodotti. Si invita alla consultazione del sito Internet www.bardiani.com nel quale è pubblicata l'ultima versione aggiornata del "Manuale di Istruzioni, Uso e Manutenzione".
- 7 Il contenuto e la durata della garanzia dei prodotti di Bardiani Valvole S.p.A. sono disciplinati nella relativa sezione del "Manuale di Istruzioni, Uso e Manutenzione" che costituisce parte integrante dei prodotti medesimi.
- 8 In nessun caso Bardiani Valvole S.p.A. sarà responsabile per danni immateriali, indiretti e consequenziali quali, a mero titolo di esempio, danni o perdite di attività, di contratti, di opportunità, di tempo, di produzione, di profitti, di avviamento, di immagine ecc..

RECOMMENDATIONS

- 1 Consultation of the "Instruction, Use and Maintenance Manual" is mandatory prior to the installation, use and maintenance of the products of all Products. All the information, indications, specifications, technical details provided herein are based on test data which the Manufacturer Bardiani Valvole S.p.A. holds to be reliable nevertheless the above is not deemed to be assumed as fully exhaustive inasmuch as not every possible use has been envisaged.
- 2 All the illustrations and drawings provided are to be intended as indicative and therefore not binding, the illustrations being for presentation purposes only.
- 3 It is the Buyer's duty to assess the suitability of the Products for the use he intends to make of the same prior to placing the order as he/she will take the risks and accept liability in case of incorrect choice and use of the Products.
- 4 The Manufacturer strongly recommends the Buyer to contact their sales team and request any information that might be needed in relation to the specifications and uses of the Products.
- 5 The information provided in this manual refers to the standard products manufactured by Bardiani Valvole S.p.A. and therefore cannot be assumed to apply to customized products as well.
- 6 Bardiani Valvole S.p.A. reserves the right to amend and/or integrate and/or update the data and/or information and/or technical details relative to Products at any time and without prior notice. Please visit the website www.bardiani.com, where the latest updated of the "Instruction, Use and Maintenance Manual" can be found".
- 7 The content and validity of the warranty covering the Products of Bardiani Valvole S.p.A are dealt with in the relevant section in the "Instruction, Use and Maintenance Manual" which constitutes an integral part of the Products themselves.
- 8 Bardiani Valvole S.p.A., shall not in any way be held liable for immaterial, indirect and consequential damages, such as (by way of example only), damages or loss of business, contracts, opportunities, time, production, profits, goodwill, image etc..